

# Grant



## **Combined refrigerated and heating bath circulator**

**LT ecocool 100**

*Operating Manual*

**Grant Instruments**, based near Cambridge, England is a world leader in the manufacture and design of equipment for sample preparation, scientific analysis, data acquisition and data analysis providing solutions to the global scientific and industrial markets.

### **Standards Compliance and Quality**

Grants' brand and reputation are based around quality, reliability and accuracy. We ensure our products stringently meet all necessary international safety standards. We pay particular attention to the safety testing of products and remain at the forefront of the product safety standard for laboratory equipment IEC 61010-1. The company is committed to operating its safety test laboratory in accordance with the requirements of ISO 17025.

Grant operates a Quality Management System that complies with the requirements of BS EN ISO 9001.

Beyond compliance to the standard, Grant is committed to continually improving in everything we do; with particular emphasis on understanding what matters to our customers and suppliers, and designing our systems and work to meet their needs.

If you have any feedback on Grant's products or services we would like to hear from you. Please send all feedback to:

Quality Manager  
Grant Instruments (Cambridge) Ltd  
Shepreth  
Cambridgeshire  
SG8 6GB  
UK

Tel: +44 (0) 1763 260 811  
Fax: +44 (0) 1763 262 410  
E-mail: [support@grantinstruments.com](mailto:support@grantinstruments.com)

Sales  
Tel: +44 (0) 1763 264 741  
E-mail: [salesdesk@grantinstruments.com](mailto:salesdesk@grantinstruments.com)

# Contents

---

Contents	2
1.0 Use of products	4
2.0 How to use this operating manual	4
3.0 Safety information	4
3.1 Safety compliance	4
3.2 Safety symbols	4
3.3 Safety warnings	5
4.0 Operating instructions	6
4.1 Unpacking instructions	6
4.2 Installation	6
4.3 Fitting the communications lead	6
4.4 Electrical supply	7
4.5 Recommended liquids	7
5.0 Operating procedures	8
5.1 Preparing the LT ecocool100 for use	8
5.1.1 Liquid level	8
5.1.2 Tank lid	8
5.1.3 Setting the over-temperature thermostat	8
5.1.4 Using the control unit pump	9
5.1.5 Rotating the control unit	9
5.1.5 Emptying the liquid tank	10
5.1.6 Setting up and switching on	10
5.1.7 Eco mode cooling	11
5.2 Using the LT ecocool100	12
5.2.1 Product description, control unit	12
5.2.2 Product description, control unit indicators	12
5.2.3 Product description, control unit rear panel	13
5.2.4 Product description, refrigeration unit front panel (grille removed)	14
5.2.5 Product description, refrigeration unit rear panel	15
5.2.6 Setting the control temperature	16
5.2.7 Selecting liquid type	16
5.2.8 Configuring a preset	16
5.2.9 Running a bath preset	17
5.2.10 Setting a countdown timer	17
5.2.11 Cancelling the timer	18
5.2.12 Setting a high temperature warning alarm	18
5.2.13 Controlling the external pump power	18
5.2.14 Selecting cooling mode	18
5.2.15 Completing a calibration	19
5.2.16 Restoring factory calibration settings	20
5.2.17 Adjusting display brightness	20
6.0 Technical specifications	21
6.1 Operating conditions	21
6.2 Electrical details	21
6.3 Performance	21
6.4 Storage and transportation	21
7.0 Technical Tips	22
7.1 Which water should you use in your LT ecocool100?	22
7.2 How to prevent rust in the LT ecocool100	22
7.3 How to prevent algae and bacteria?	23
8.0 Warranty information	24
9.0 Maintenance and service	24
9.1 Routine maintenance	24

9.2	Cleaning	24
9.3	Fuses	25
9.5	Routine safety tests	25
9.6	Service	26
10.0	Optional accessories	27
10.1	Alternative pump	27
10.2	Pump connectors and other accessories	27
11.0	Troubleshooting	29
12.0	Contact Grant Instruments	32
13.0	Compliance	32
	Notes	33

## 1.0 Use of products

---

The following products are covered by this operating manual:

- LT ecocool100
- LT ecocool100 AUS
- LT ecocool100 US

The products listed above are combined refrigerated heating and bath circulators designed for indoor laboratory use by or supervised by a professional user.

The LT ecocool100 consists of a T ecocool100 heating circulator and an R ecocool100 refrigeration bath. Both parts of the system are designed to work together and will not work independently or with other heating and refrigeration models.

Insulated hoses and clips allow circulation of temperature controlled fluids to external equipment.

## 2.0 How to use this operating manual

---

This operating manual will allow you to unpack, set-up and operate this low temperature bath/circulator correctly and safely. Important safety information, symbols and warnings are listed below and should be read carefully before operating the product. Section 4 gives information about how to unpack and install the product correctly. Section 5 gives operating information for the LT ecocool100. Product technical specifications and tips are provided in sections 6 and 7. The warranty for this product is for FOUR YEARS and should be registered by completing the on-line registration form which can be found at [www.grantinstruments.com](http://www.grantinstruments.com). Full details of warranty conditions can be found in section 8 of this manual

If you have any questions regarding the operation of this product please contact your local distributor or Grant instruments who will be able to assist you with your enquiry.

## 3.0 Safety information

---

### 3.1 Safety compliance

The LT ecocool100 meet the requirements of international safety standard IEC 61010: Safety requirements for electrical equipment for measurement, control, and laboratory use.

### 3.2 Safety symbols

The symbols below are marked on the equipment and throughout this manual to indicate:



Caution: Surfaces and heat transfer liquid can be hot during and after use.



Read this manual before using the bath.



Warning: A hazard is present that can cause personal injury. Do not proceed beyond a warning until the indicated conditions are fully understood or met.

### 3.3 Safety warnings



Read the whole of these instructions. Safety may be impaired if they are not followed.



This product should only be used by a competent and trained person.



Only use liquids specified in these operating instructions, within the specified temperature range. Do not inhale the vapours given off as they may be toxic. Liquids should be safely discarded and replaced.



Makes sure the correct fluid type has been selected in the controller to ensure the correct temperature limits are used.



Do not use the LT ecocool100 series unit with any sample material that could cause a fire or any other kind of hazard.



Do not use the equipment in an area where there are aggressive or explosive chemical mixtures.



If a potentially hazardous liquid is spilt onto or inside the equipment, disconnect it from the power supply and have it checked by a competent person.



Before moving, disconnect from the mains power supply.



It is the user's responsibility to carry out appropriate decontamination if hazardous material is spilt on the equipment.



If there is a warning message on the screen illuminated do not touch the liquid or the tank base, they may be very hot. Refill carefully, a hot heater can cause a spattering of very hot water droplets and scalding steam.



Do not touch surfaces which become hot during high temperature operation.



It is the user's responsibility to carry out a risk assessment when operating this product within the user's own equipment setup and operating environment.

## 4.0 Operating instructions

---

### 4.1 Unpacking instructions

Standard equipment includes:

- LT ecocool100 refrigerated and heating bath circulator
- Ready to use 2 metre insulated hose kit
- 2 additional hose clips
- Mains cord with plug
- Mains cord for control unit - 230V unit only
- Communications lead
- Operating manual & Safety information sheet



The LT ecocool100 weighs 29kg. Take necessary precautions when lifting.

Remove packing materials carefully and retain them for future shipment or storage of the equipment.

### 4.2 Installation

After transportation, let the unit stand in its intended working position for six hours. This is to allow the oil to drain to the bottom of the compressor. This is normal procedure for refrigeration compressors.

Allow at least 100mm clearance from obstructions at the front and rear so that there is free air flow through the unit.



Place the LT ecocool100 on a level, non-combustible surface. Ensure that the mains plug and the switch at the rear of the unit are easily accessible.



If the equipment has been transported or stored in cold or humid conditions, condensation may form inside it. If that could have happened, allow time (at least 2 hours at room temperature) for the condensation to evaporate before using the equipment.



Do not block or restrict ventilation slots. Allow at least 100mm clearance from obstructions



Do not connect to a power supply or switch on before filling the tank.



Drain before moving the bath. Liquid to be drained should not be below 10°C or above 50°C.



Always operate the unit with the condenser grille fitted.

The control unit is fitted ready to use with the pump ports facing the left hand side. If required the control unit can be rotated so the pump ports face the rear.

To rotate, remove the thumbscrew at the rear of the refrigeration unit and lift up the control unit and top plate. Remove the 2 thumbscrews from the underside of the top plate to release the control unit. Rotate the control unit on the top plate and refit.

### 4.3 Fitting the communications lead

Connect the communications lead from the control unit to the refrigeration unit. The connecting ports are shown in Section 5.2.3, and 5.2.5. This enables the control unit to

control the cooling power. If the lead is not connected correctly the control unit will display the fault 'Check the refrigeration unit'

#### 4.4 Electrical supply



Connect the LT ecocool100 to a grounded (earthed) electrical power supply with voltage and frequency within the range specified on the serial number plate.



The LT ecocool100 must only be connected to the mains using the mains cord supplied or one with an identical rating (see section 9.4)



Ensure the mains switch and isolating device (power supply connector) is easily accessible during use.

The 230V version control unit is powered from the refrigeration unit using the interconnect cable supplied. Plug the mains cable into the power inlet socket on the rear of the refrigeration unit. Take care not to plug the control unit into the pump power port. See Section 5.2.4 for location of the power sockets. The 120V control units should be connected directly to the mains supply; it cannot be powered from the refrigeration unit.

#### 4.5 Recommended liquids

The following table lists the recommended liquids for different temperature ranges. Always ensure the liquid used is safe and suitable for your working temperature.

It is the user's responsibility to assess the risks associated with the choice of heat transfer liquid chosen and to put in place safe working practises and appropriate protective equipment for personnel where considered necessary.



To ensure protection, the overtemperature cut-out must be set appropriately for the heat transfer liquid selected (see table below).



Use fume extraction when using silicone fluids at elevated temperatures

Temp range	Recommended liquid	Comments
-20°C to 50°C	50% water, 50% antifreeze (inhibited ethylene glycol)	Ethylene glycol is toxic – follow the manufacturer's instructions. For safe disposal consult the local regulations. Use a lid to reduce the dilution of the mixture caused by condensing water vapour from the air, and to maintain the cool down rate.
0°C to 50°C	80% water, 20% antifreeze (inhibited ethylene glycol)	
5°C to 95°C	Water*	Water can be used but care should be taken above 60°C as hot vapour can be dangerous. The units should not be used to boil water.
0°C to 100°C	Silicone fluid Viscosity ~20cs Flash point ≥230°C Fire Point ≥280°C	Dow Corning DC200/20 silicone fluid is a suitable liquid – follow the manufacturer's instructions. For safe disposal consult the local regulations.

\* See section 7.1 for further details



## 5.0 Operating procedures

---

### 5.1 Preparing the LT ecocool100 for use

#### 5.1.1 Liquid level

Remove the lid and fill the tank to an appropriate level with a liquid suitable for your working temperature; see section 4.3 for liquid options.

Maximum fill level	145mm (10mm from the top of the tank)
Minimum fill level	85mm (70mm from the top of the tank)

If silicon oil is used, adjust the maximum and minimum fill levels to allow for thermal expansion and contraction of the liquid during operation to prevent overspill. Allow for any liquid in external circulation paths. If using liquids that can evaporate then periodic checking and refilling should be completed. The fluid must cover the cooling coil to maintain the cooling power and prevent condensation. Refit the lid when filling is complete.

The low level float switch will alarm if the liquid level drops below the minimum level for safe operation of the heaters. The unit will switch off the heating, cooling and pumping. Temperature control will stop.

#### 5.1.2 Tank lid

Always keeps the lid fitted when operating the unit.



Take care when lifting and removing the lid as it may be hot. Steam and hot vapours can cause scalding.

#### 5.1.3 Setting the over-temperature thermostat

An over-temperature cut-out dial with a temperature scale is located at the top right of the unit. The over-temperature probe independently monitors the bath temperature and switches the heater off if it goes above the cut-out threshold.

##### Coarse setting of the over-temperature thermostat

Align the temperature cut-out dial to the desired temperature on the marked scale. The chosen setting should be higher than the set working temperature to avoid operating the cut-out before the set temperature has been reached. If the alarm is triggered the sounder can be silenced by pressing either the **F** or **S** button once. To continue to use the control unit, the bath liquid must be allowed to cool by at least 5°C. Cooling can be achieved by either waiting for the liquid to cool naturally or by replacing the liquid. Once the liquid has cooled sufficiently, switch the unit off, wait 10 seconds and switch it on again to clear the alarm. To avoid nuisance tripping ensure that the trip is set at least 5°C above the desired set working temperature.

##### Alternative setting of the over-temperature thermostat

Rotate the temperature cut-out dial to maximum (or at least a value above the level required) and configure the set temperature to the cut-out level required. Leave the bath to reach the set temperature and stabilise for at least 5 minutes. Turn the cut-out dial slowly anticlockwise until an over-temperature fault is displayed on screen and the alarm





sounds continuously. This gives an over-temperature trip point at the set temperature. The audible alarm can be cancelled by pressing either the **F** or **S** button once. To continue to use the control unit, let the bath liquid cool by at least 5°C, either naturally or by replacing the liquid, switch the unit off, wait 10 seconds and switch it on again to clear the alarm. To avoid nuisance tripping the trip point needs to be set at least 5°C above the desired control temperature.

#### 5.1.4 Using the control unit pump

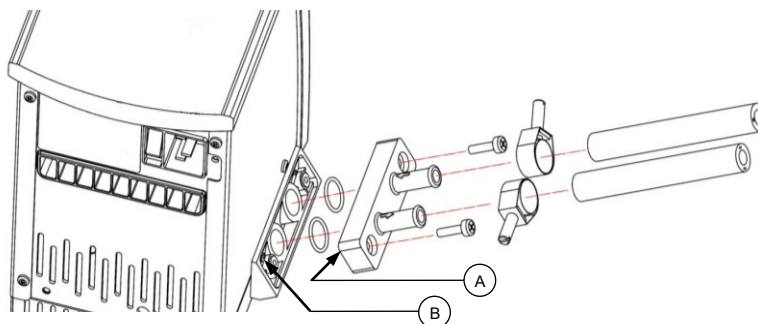
The LT ecocool100 allows liquid to be pumped around a closed external system (not open to the atmosphere). It cannot be used for circulation through an external open tank. The pump is fitted with a blanking plate as standard. Fit a pump connector plate as shown below. Ensure o-rings are located in the grooves, use silicone grease to hold the o-rings in place. Note: the blanking/connector plates have a locating hole (see A below) to assist correct alignment onto the pump moulding. It is important to verify the hole is aligned with the corresponding locating pin (see B below) on the pump moulding. Failure to do so will result in a leaking connection. Retain the blanking plate for refitting when the pump is no longer required.

The LT ecocool100 is supplied with insulated hose which is designed to operate at temperatures between -40°C to 100°C. Suitable high temperature hose HOSE 200 is recommended for temperatures above 100°C.



-  Always use pump connectors and hoses that are suitable for the operating temperature and liquid used. Check the pipe connections are secure.
-  Never disconnect any pipes or hoses while they contain very hot or very cold liquids or while the LT ecocool100 is pumping.
-  Never use silicone oil with silicone tubing.
-  Switch off the unit when connecting and disconnecting hoses

Pumping heat transfer liquid around an external system can lead to hazards that are outside the control of Grant Instruments. It is essential that the user conducts a risk assessment of the entire equipment installation to ensure that correctly rated materials have been used throughout and that the system can be used safely.

#### 5.1.5 Rotating the control unit

The control unit is fitted ready to use with the pump ports facing the left hand side. If required the control unit can be rotated so the pump ports face the rear and the user controls are accessed from the left hand side.

Consider rotating the control unit, if following a risk assessment, access to hot surfaces needs to be reduced.

To rotate, remove the thumbscrew at the rear of the refrigeration unit and lift up the control unit and top plate. Remove the 2 thumbscrews from the underside of the top plate to release the control unit. Rotate the control unit on the top plate and refit.

### 5.1.5 Emptying the liquid tank

The LT ecocool100 tanks should be emptied to a safe level prior to moving. A drain tap is provided to allow convenient emptying. See section 5.2.4 for full details.



Liquid to be drained should not be below 10°C or above 50°C

### 5.1.6 Setting up and switching on

Follow instructions in section 5.1.3 to attach the pump connector plate and insulated hose. Before filling and switching on, attach the open end of the hose to the application, taking care to note the inlet and outlet.



Ensure all hoses are connected securely. Liquid will begin pumping immediately once the LT ecocool100 is switched on.

Add the appropriate working liquid to the bath to at least the minimum recommended fill level such that the float level switch is fully raised.

For 230V version the control unit is powered from the refrigeration unit using the interconnect cable supplied. Plug the mains cable into the power inlet socket on the rear of the refrigeration unit. Take care not to plug the control unit into the pump power port. See Section 5.2.4 for location of the power sockets. For 120V control units the unit should be connected directly to the mains supply separate to the base unit

Connect the refrigeration unit directly to the mains using the IEC cable provided.

For 230V operation. Make sure the control unit power switch is in the ON position. Switch on the LT ecocool100 control unit using the power switch on the front of the refrigeration unit. The control unit motor will start immediately and the buzzer will sound while the unit starts up. The control unit will display `EECC` followed by the software version number. `r 100` will then be displayed to indicate the refrigeration unit is correctly responding. `EECC` will then be displayed to indicate the cooling mode. The display will then show the current liquid temperature. The LT ecocool100 will start to control at the current Set Point temperature.

For 120V version the base unit and control unit must be switched on separately. Note that the refrigeration unit will not operate until the control unit is working.

The control unit is powered from the refrigeration unit using the interconnect cable supplied. Plug the mains cable into the fused power inlet socket on the rear of the refrigeration unit. See Section 5.2.4 for location of the power sockets. For 120V control units the unit should be connected directly to the mains supply.

When working at high temperatures, ensure the cables are not touching hot surfaces or air vents

Switch on the refrigeration unit using the power switch on the front of the unit. The control unit motor will start immediately and the buzzer will sound. The control unit will display  $\text{ECC}$  followed by the software version number.  $\text{r 100}$  will then be displayed to indicate the refrigeration unit is correctly connected. The LT ecocool100 will now display the current liquid temperature and start to heat or cool to reach the set point temperature.

### **5.1.7 Eco mode cooling**

The LT ecocool100 has variable power cooling as well as a heating system. This enables the system to achieve and maintain the required temperature using minimum energy without a loss in performance. The LT ecocool100 is preset to run in this energy saving Eco mode. The cooling can also be set of OFF or constant HIGH power. See section 5.2.13 to configure the cooling mode

## 5.2 Using the LT ecocool100

### 5.2.1 Product description, control unit



### 5.2.2 Product description, control unit indicators

There are two indicator lamps on the control unit:

- Heater on lamp (orange) marked  $\SSS$
- Alarm lamp (red) marked !

The alarm lamp will illuminate to indicate the following faults:

- Float switch has operated due to low liquid level
- Over temperature cut out has operated
- Temperature probe fault

The cause of the alarm will also be shown on the display.

The display normally shows the temperature of the liquid being controlled in °C

The **S**(et) button is used to select and store values whilst the **F**(unction) button is used to access menu options and cancel functions.

The main dial is used to change temperature values and other user settable parameters.

### 5.2.3 Product description, control unit rear panel

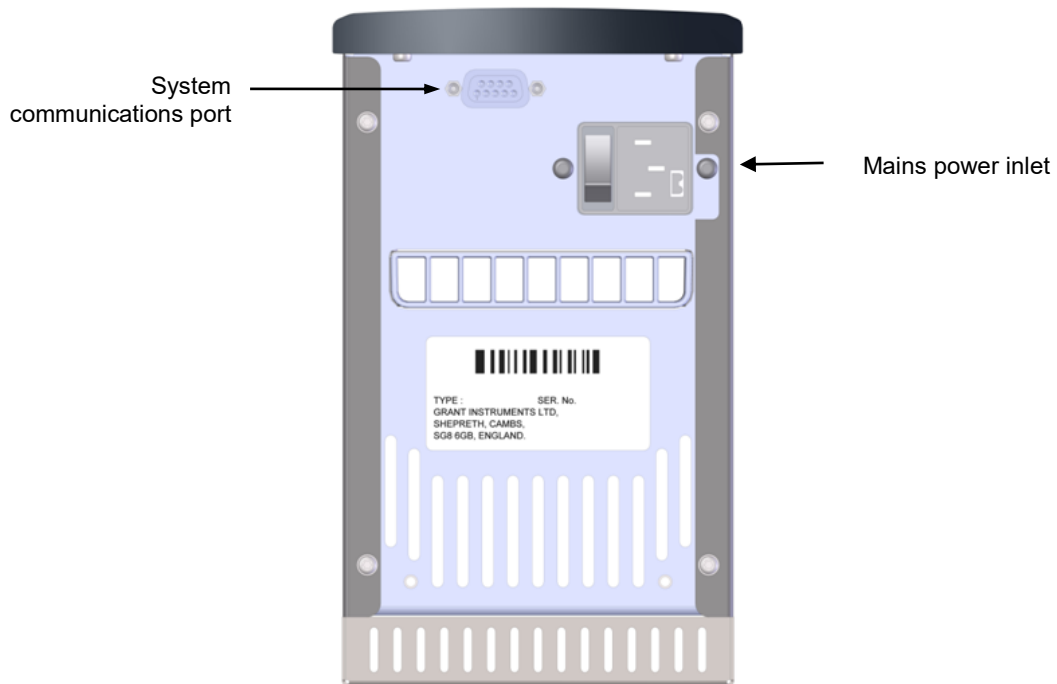

#### System Communications port

The system communications port provides communications between the control and refrigeration units. The communications cable should remain connected at all times. Only use the communications port cable supplied with the system. Do not connect anything else to this communication port

#### Mains Power cable inlet and switch

For connection to the mains power outlet on the refrigeration unit. Use the mains cord supplied with the system.

For 120V units there is a fixed mains cable with plug fitted for connection directly to a mains power outlet.

## 5.2.4 Product description, refrigeration unit front panel (grille removed)

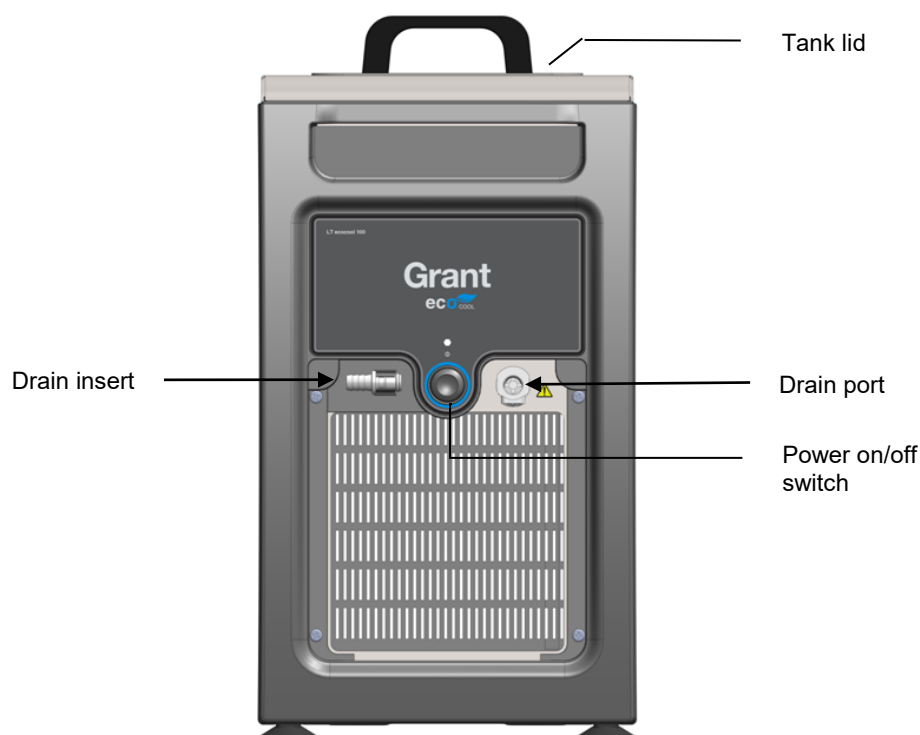

### Drain port and drain insert

To access the drain port, pull out the top of the front grille and lift away.

The drain port and insert allow convenient emptying of the refrigeration bath. To drain the unit first remove the drain insert from the holder and connect a suitable length of hosing to the drain insert. Have the non connected end of tubing in a receptacle, suitable for the liquid to be drained. Push the drain insert into the drain port and let the liquid drain. To release the drain insert push up the grey button on the drain port and extract the drain insert.



Liquid to be drained should not be below 10°C or above 50°C.

Although the drain has been designed for minimum leakage it is advisable to place an absorbent cloth under the drain port to catch any drips.

Always replace the front grille after draining.

### Power on/off switch

Push switch to power on and off the system

## 5.2.5 Product description, refrigeration unit rear panel

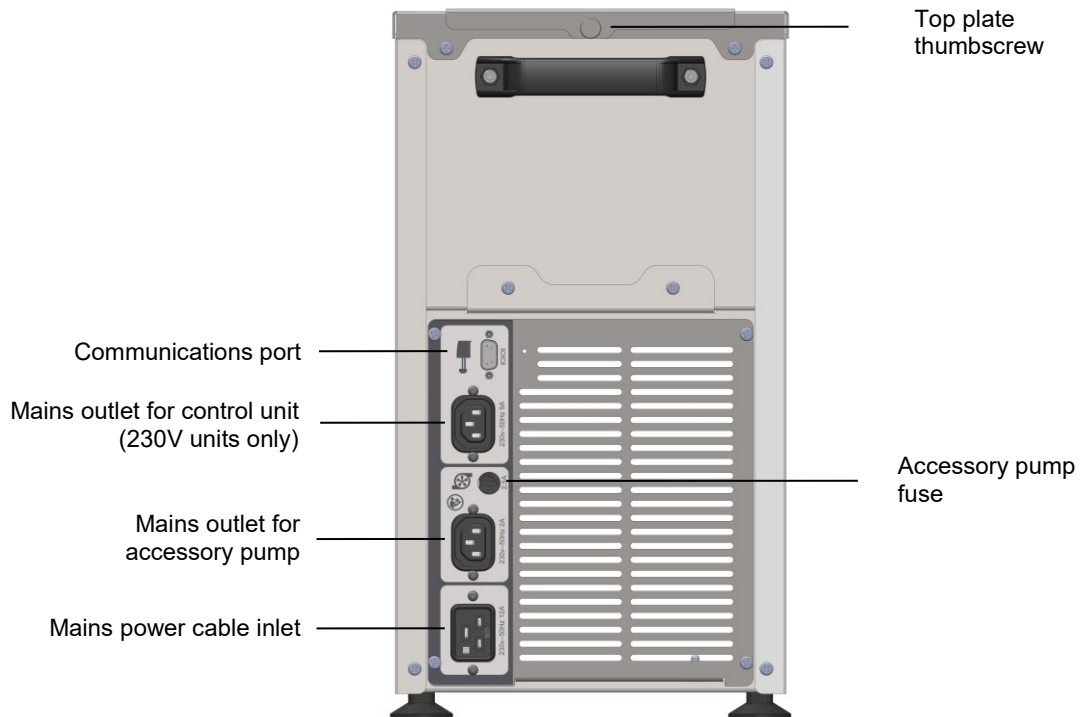

### Communications Port

The system communications port provides communications between the control and refrigeration units. The communications cable should remain connected at all times. Only use the communications port cable supplied with the system. Do not connect anything else to this communication port

### Mains power outlet for control unit (230V units only)

Provides power for 230V control unit. Use the cable supplied with the system. For 120V units, the control unit must be powered separately

### Mains power outlet for accessory pump

Optional power connection for an accessory pump. Power can be set ON using the Settings menu. See section 5.1.10

### Mains power cable inlet

For connection to a mains power supply. Use the mains cord supplied with the system. See Section 4.4 for instructions

### Top plate thumbscrew

To remove the control unit from the bath for cleaning, first unfasten this thumbscrew. Slide the top plate backwards and lift to completely remove the control unit.



## 5.2.6 Setting the control temperature

The temperature of the circulation liquid is set using the **S** button.

1. Whilst the display is showing the bath temperature, press the **S** button. This will cause the display to flash indicating that it can be set.
2. Use the main dial to set the desired temperature.  
*If no key is pressed for 10 seconds then the display will revert back to showing the bath temperature and the set temperature will remain at its original value.*
3. Press the **S** button to store the requested value and the display will revert to showing the bath temperature.  
*If the temperature selected is higher than the current liquid temperature, the heater light will come on.*

## 5.2.7 Selecting liquid type

The type of liquid selected limits the temperature range available for safe operation of the unit. It is important the liquid selected matches the actual liquid in the tank.

It is the user's responsibility to assess the risks associated with the choice of heat transfer liquid chosen and to put in place safe working practises and appropriate protective equipment for personnel where considered necessary.

1. Press the **F** button four times – the display will show the current liquid type.
2. Use the main dial to select the required liquid.

Liquid	Set temperature range
H <sub>2</sub> O	5°C to 100°C
Oil	0°C to 100°C
LTL	-20° to 50°C

\* LTL = low temperature liquid, for example 50% water/50% glycol

3. Press the **S** button to set the liquid type and return to normal temperature display.
4. Change the Over Temperature thermostat to be approximately 5°C above the new working set point temperature. See section 5.1.3



To ensure protection the over-temperature cut-out must be set appropriately for the heat transfer liquid selected.



When changing the liquid from water to oil for operating above 100°C, ensure all residue of water is removed from the pump and hoses. There is a risk of scalding from boiling water.

## 5.2.8 Configuring a preset

The LT ecocool100 can be configured with three temperature presets to allow the circulator to be conveniently run at frequently used temperatures. The method below is used to configure preset 1; the other presets can be set in a similar manner.

Be aware that once a preset has been saved, it will automatically operate once the steps below have been completed.

1. Press the **F** button and rotate the dial until the display shows “t 1”.  
*The display will alternate between the preset number and its temperature.*
2. Press the **S** button to select the preset.
3. Use the dial to set the desired preset temperature.  
*If no key is pressed for 10 seconds then the display will revert back to showing the bath temperature and the preset temperature will remain at its original value.*
4. Press the **S** button to save the preset temperature.  
*The preset will automatically start as soon as the value is saved.*

Preset temperatures and set temperatures are limited to between -20°C and 100°C. The factory preset settings are shown in the following table.

Preset	Set temperature range
t-1	37°C
t-2	56°C
t-3	72°C

### 5.2.9 Running a bath preset

1. Press the **F** button and rotate the dial until the display shows the correct preset.
2. Press the **S** button to select the preset.
3. Press the **S** button to set the bath to the preset temperature.

### 5.2.10 Setting a countdown timer

The LT ecocool100 includes a countdown timer in minutes which triggers an audible alarm on completion. The timer can be set between 1 minute and 6000 minutes (100 hours).

1. Press the **F** button twice – the display will show “[ L o c ”.
2. Press the **S** button to select.
3. Use the main dial to select “00” and press the **S** button to select. The display flashes with time (in minutes) indicated. Rotate navigator control to set time required.
4. Press the **S** button to save and return to liquid temperature display with timer countdown started.

When the countdown clock is set the display alternates between bath temperature and time remaining in minutes.

When the countdown timer reaches zero the audible alarm will sound and the display will alternate between the water temperature and “End”. The alarm can be accepted by pressing the either the **F** or **S** buttons.

**Note: the LT ecocool100 will continue to control at the set temperature after the timer reaches zero – the heater will not switch off.**

### 5.2.11 Cancelling the timer

The countdown timer can be easily cancelled.

1. Press the **F** button twice – the display will show “CLoc”.
2. Press the **S** button to select.
3. Use the main dial to select “Off” and press the **S** button to select. The display will revert to the bath temperature and the timer will be cancelled.

### 5.2.12 Setting a high temperature warning alarm

To set the level of the high temperature warning alarm, follow the steps below.

1. Press the **F** button three times – the display will show “ALAr”.
2. Press the **S** button to select.
3. Use the main dial to select “On” and press the **S** button to select. The display flashes the high temperature alarm value. Rotate the dial to set the high temperature alarm required.
4. Press the **S** button to save and return to liquid temperature.

If the high temperature alarm value is exceeded then LT ecocool100 will sound the buzzer intermittently and show “-AL-” on the display. The alarm can be acknowledged by pressing either the **F** or **S** buttons. However, the alarm is persistent and will trigger again if the temperature still exceeds the high temperature value. The alarm can be cancelled by following the steps above but using the dial to select “OFF” in step 3 and pressing the **S** button to confirm.

**Note: the high temperature alarm will not switch off the heater.**

### 5.2.13 Controlling the external pump power

An external pump, powered from the rear panel can be switched on and off using this menu.

1. Press the **F** button five times – the display will show “PUMP”.
2. Press the **S** button to select. The display will show the current mode
3. Use the main dial to select the required mode of operation.

Mode	Operation
OFF	Pump permanently off
On	Pump permanently on

3. Press the **S** button to save.

Note that if a pump is already connected, it will start pumping immediately. The control unit will remember the pump setting when switched off.

### 5.2.14 Selecting cooling mode

The refrigeration cooling is set to energy saving eco mode at the factory. The user can change this setting if required.

1. Press the **F** button six times – the display will show "E00L".
2. Press the **S** button to select. The display will show the current mode
3. Use the main dial to select the required mode of operation.

Mode	Operation
OFF	Cooling permanently off
EEO	Energy saving eco mode
HI	Cooling permanently on maximum power

3. Press the **S** button to save

Note: The cooling mode currently selected is displayed during the unit power on sequence.

### 5.2.15 Completing a calibration

The LT ecocool100 allows a two point calibration to be completed. The calibration menu can be accessed by pressing the **F** and **S** buttons simultaneously for about 5 seconds.

The calibration temperatures are constrained by the temperature limits of the liquid type setting. Calibration should be carried out using a traceable reference thermometer with an accuracy of at least 0.1°C. This thermometer should be held securely in the centre of the bath or vessel.

The calibration of the LT ecocool100 is performed by setting, a low temperature calibration point and a high temperature calibration point. The high temperature calibration point must be at least 40°C higher than the low temperature point.

Calibration points should be chosen to be at critical experimental temperatures where accuracy is important or, alternatively, at the extremes of the working range of used temperatures.

If only the low temperature calibration point is set; then the calibration will be performed between this point and 100°C with the offset decreasingly linearly. If only the high temperature calibration point is set; then the calibration will be performed between 0°C and this point with the offset decreasingly linearly.

In order to achieve an accurate calibration it is important to ensure that the liquid temperature is stable. If following calibration the temperature indicated on the LT ecocool100 is not in accordance with the thermometer the unit should be reset.

#### Setting the low temperature offset

1. Adjust the set temperature to the required low temperature calibration point.
2. Allow the unit to stabilise for at least 5 minutes after a stable temperature condition has been achieved.
3. Measure the liquid temperature by placing a reference thermometer into the centre of the bath.
4. Press the **F** and **S** buttons simultaneously for approximately 5 seconds until "LRL" is shown.
5. Press the **S** button to select.
6. Use the main dial to update the display to show the temperature on the reference thermometer.
7. Press the **S** button to store the temperature.  
*Press the F button to cancel the calibration.*

8. Press the **F** button to return to the liquid temperature display.

#### **Setting the high temperature offset**

1. Adjust the set temperature to the required high temperature calibration point.
2. Allow the unit to stabilise for at least 5 minutes after a stable temperature condition has been achieved.
3. Measure the liquid temperature by placing a reference thermometer into the centre of the bath.
4. Press the **F** and **S** buttons simultaneously for approximately 5 seconds until "LCL" is shown.
5. Rotate the dial until the display shows "HCL" and press the **S** button to select.
6. Use the main dial to update the display to show the temperature on the reference thermometer.
7. Press the **S** button to store the temperature.  
*Press the F button to cancel the calibration.*

#### **5.2.16 Restoring factory calibration settings**

The restore factory calibration allows the unit settings to be reset if there is a problem during calibration or you wish to cancel any of the calibration settings.

1. Press the **F** and **S** buttons simultaneously for approximately 5 seconds until "LCL" is shown.
2. Rotate the dial until the display shows "r5t" and press the **S** button to select.
3. Press the **S** button three times (the display will show "Con\_3", "Con\_2", "Con\_1" and sound the buzzer to confirm the factory reset has been completed).

#### **5.2.17 Adjusting display brightness**

If required the brightness level of the display can be adjusted over a range of 20% to 100%

1. Press **F** and **S** buttons simultaneously for approximately 5 seconds until the display shows "LCL".
2. Rotate the dial until the display shows "d 5P" and press the **S** button to select.
3. Rotate the dial between the settings and select required brightness  
*The displayed values show the display brightness*
4. Press **S** button to save the value.
5. Press **F** button to return to the normal temperature display.

## 6.0 Technical specifications

---

### 6.1 Operating conditions

Ambient temperature range	5 to 40°C
Altitude above sea level	Up to 2,000m (6,500ft)
Operating environment	Indoor use only
Maximum relative humidity	80% RH up to 31°C decreasing to 50% RH at 40°C

### 6.2 Electrical details

Mains supply: 220-240V @ 50 or 60Hz\* or 110-120V @ 50/60Hz  
Pollution degree: 2  
Installation category: II

\*220-240V units can only operate at a single mains frequency. Check unit rating plate  
Mains supply voltage fluctuations are not to exceed  $\pm 10\%$  of the nominal supply voltage.

### 6.3 Performance

Specification		LT ecocool100 ecocool100 AUS	LT LT ecocool100 US
Typical cooling power at an ambient of 20°C	@ 20°C	240W	
	@ 0°C	200W	
	@ -10°C	100W	
	@ -20°C	30W	
Stability (DIN 12876) @ -10°C		$\pm 0.05^\circ\text{C}$	
Settable temperature range		-20°C to 100°C	
Tank capacity		5L	
Top opening		120 x 155mm	
Tank depth		155mm (usable 145 leaving 10mm clear)	
Liquid depth min/max		85/145mm	
Weight		29kg	
Max pump head pressure		250mBar	
Max pump flow rate		17L/min	
Safety high temperature limit		Adjustable cut-out above 20°C	
Max current consumption (both units excluding external pump)		9A	18A*
Heater power		1.3kW	1.4kW

\*Requires two separate mains cords

### 6.4 Storage and transportation

Store and transport in original packaging. Temperature range -20°C to +60°C

---

## 7.0 Technical Tips

---

### 7.1 Which water should you use in your LT ecocool100?

For the long-term reliability of LT ecocool100 it is important to use oxygenated water that is free from ions and minerals that can cause corrosion of stainless steel. We recommend the use of distilled water and de-ionised water from modern ion exchange systems that do not use salt back flushing to regenerate the ion-exchange cartridges.

Stainless steel is protected from corrosion by a layer of chromium oxide. If the chromium oxide layer is damaged, oxygen present in water can reform the oxide layer. If the water is distilled or de-oxygenated, and the oxide layer is damaged, ions can corrode the stainless steel tank. If a water bath has been unused for some time, or the water has been boiled, we recommend changing to fresh distilled water or the correct type of de-ionised water as explained below.

Water normally contains calcium or magnesium ions. De-ionised water has most ions removed as indicated by its conductivity level; the purer the water the lower the conductivity. It is important to use only de-ionised water from an ion exchange system with replaceable cartridges. Do not use de-ionised water generated from an ion-exchange system that incorporates a salt back-flush system to regenerate the ion-exchange resin as this can leave sodium ions that are very corrosive to stainless steel.

### 7.2 How to prevent rust in the LT ecocool100

Most Grant tanks, and other parts which are immersed in water, are made from type 304 stainless steel. Type 304 stainless steel is an extremely versatile general purpose grade of stainless steel. It is the excellent forming characteristic that has made this grade dominant in the manufacture of laboratory and industrial water baths, as well as domestic sinks and saucepans. Type 304 stainless steel is highly suitable for applications where hygiene is important; it exhibits good heat resistance and excellent resistance to corrosion.

However, despite resistance to general surface corrosion, stainless steel is susceptible to specific types of corrosion, in particular pitting (small pin hole style corrosion) and stress corrosion cracking. It can also undergo general corrosion in specific environments, such as one containing hydrochloric or sulphuric acids.

Stainless steel is protected by its high content of alloying elements, primarily chromium and nickel. Chromium is the most important with respect to corrosion resistance, although the nickel assists in allowing the chromium to do its job. The chromium forms an oxide layer on the surface of the steel, which inhibits further oxidation. This layer adheres extremely well to the metal substrate, but it is essential that it remains intact, and must be protected from various forms of damage.

If the surface chromium oxide layer becomes damaged, oxygen present in water can partially reform the oxide layer, so it is advisable to ensure that water is always fresh and well oxygenated. Baths that will be out of use for an extended period should be emptied, and all moisture should be wiped from the bottom of the tank.

In some cases a brown layer may appear on the surface of a stainless steel tank. In most cases this is not rust, but it may be a surface deposit of minerals from the local water supply, it can also be caused by ferrous particles or salts that have fallen into the tank. These surface deposits can usually be removed by using a household metal polish.

### **7.3 How to prevent algae and bacteria?**

The LT ecocool100 provides the ideal environment for the growth of micro-organisms. If left uncontrolled the growth of these organisms can result in a range of serious problems and health risks from pathogenic bacteria.

The growth of algae on the surfaces will cause bio fouling which can reduce performance.

Micro-organisms that produce acidic metabolic by-products can cause bio-corrosion by depolarisation of metal surfaces.

There are a number of biocides available on the market.



## 8.0 Warranty information

---

When used in laboratory conditions according to this manual, this product is guaranteed for FOUR YEARS against faulty materials or workmanship.

Extended warranty for year five can be purchased by contacting our sales department at [salesdesk@grantinstruments.com](mailto:salesdesk@grantinstruments.com).

## 9.0 Maintenance and service

---

### 9.1 Routine maintenance

The over-temperature cut-out on the control unit should be checked periodically by turning the over-temperature dial with a screwdriver anticlockwise until the alarm lamp illuminates. The control unit will also sound a buzzer and “Cut” will be shown on the display. The over-temperature dial should then be turned to the maximum setting without the alarm cancelling. The control unit should be powered off and back on to confirm that the cut-out can be reset correctly. If the alarm lamp fails to illuminate when the value indicated on the over-temperature dial is more than 10°C below the current temperature as indicated by the main display, then the unit should be checked by a competent person.

The float liquid level protection should also be checked periodically by lowering the level of liquid in the bath and noting that the unit cuts out with the top turn of the heater coil still immersed in the liquid.

When hoses are fitted to the pump they should be inspected periodically and replaced as necessary to avoid hose failure.

No other routine maintenance is required.

### 9.2 Cleaning

Regular maintenance of the LT ecocool100 is important to allow the unit to perform to its specification and is required for validity of the warranty.

A removable grille enables easy access to the condenser for cleaning. Cooling power will be reduced if the fins become clogged with dust. The condenser fins (see section 5.2.3) should be examined monthly and, if necessary, use a vacuum cleaner nozzle and soft brush to remove the dust.

Take care not to damage the condenser fins during cleaning. Always replace the condenser grille following cleaning



Allow the unit to cool before cleaning the condenser fins



Unplug the units from the mains before commencing cleaning

Clean the outside of the equipment with a damp cloth, using water only. Do not use chemical cleaning agents. Before using any other cleaning or decontamination method, check with Grant Instruments or your local representative to make sure that the proposed method will not damage the equipment.

To aid cleaning the control unit can be removed from the liquid tank. Unfasten the thumbscrew at the rear of the refrigeration unit and lift the control unit and top plate. Scale on immersed parts can be removed using chemical de-scaling products designed for use on equipment that has metal parts. De-scaling products may be toxic and manufacturer's instructions should always be followed

### 9.3 Fuses

Both the control unit and refrigeration unit fuses are internal and should not need to be replaced. Please contact the Grant Instruments service department if the unit has a fuse fault.

The external pump power outlet has a user replaceable fuse. Replacement fuses must be 20mm x 5mm Quick blow ceramic type with 250V 2.5A rating.

Fuse replacement should only be carried out by a competent person.

### 9.4 Replacing the mains cord

This equipment must only be used with an appropriately approved cord set acceptable for the country in which the equipment is intended to be used.

The mains cord set must be suitably rated for the equipment it is intended to be used with, refer to the equipment rating label for further details.

No user replaceable parts, if the cord set is damage do not operate the equipment, disconnect from the supply immediately and contact Grant Instruments for replacement or your authorised service agent.

#### Guidance information table

Country	Cord type	Mains Plug	Appliance coupler
US	SJTW 14AWG 105°C	NS-3P	Not applicable
Canada			Not applicable
UK	H05VV-F 3G1.5mm <sup>2</sup> , 300/500V 90°C	BS 1363	IEC 60320, Type C20
Europe		IEC 60309	IEC 60320, Type C20

### 9.5 Routine safety tests

If routine tests are to be made, we recommend a test of the integrity of the protective earth conductor and an insulation test at 500V DC. Routine flash tests are not recommended for any electrical equipment, because repeated high voltage tests degrade insulation materials.

## 9.6 Service

If service is required, switch off the unit and contact Grant Instruments or your local representative for repairs.

Please note all returned units must be accompanied by a Return Materials Authorisation (RMA) number, obtainable by contacting the Grant service department (details below).

Service Department  
Grant Instruments (Cambridge) Ltd  
Shepreth  
Cambridgeshire  
SG8 6GB UK

Tel: +44 (0) 1763 260 811

Fax: +44 (0) 1763 262 410

E-mail: [service@grantinstruments.com](mailto:service@grantinstruments.com)











## 10.0 Optional accessories

### 10.1 Alternative pump

A pump is supplied as standard on the LT ecocool100. If greater head (pressure) is required you can choose from two accessory pumps and the appropriate pump lid. See the Grant website for further details. [www.grantinstruments.com](http://www.grantinstruments.com) for full technical specifications.

Pump Product	Description	
VTP1-LT	Max head pressure: 1000mBar Max flow rate: 9 L/min	
VTP1L-LT	Max head pressure: 1000mBar Max flow rate: 9 L/min 120V	
VTP2-LT	Max head pressure: 1700mBar Max flow rate 12 L/min	

### 10.2 Pump connectors and other accessories

Connectors	Description	
P-M6	Replacement plastic pump inlet/outlet connector, fits 9mm ID, T° range -50 to 200°C	
P-M11	Replacement plastic pump inlet/outlet connector, fits 15mm ID, T° range -50 to 200°C	
M-M16	Stainless steel pump inlet/outlet connector, M16 x 1 male, T° range -50 to 200°C	
M-SR4	Metal pump inlet/outlet connector, dual seal super rapid 4mm, fits semi rigid tubing 4mm OD, T° range -20 to 100°C	
M-SR6	Metal pump inlet/outlet connector, dual seal super rapid 6mm, fits semi rigid tubing 6mm OD, T° range -20 to 100°C	
M-SR8	Metal pump inlet/outlet connector, dual seal super rapid 8mm, fits semi rigid tubing 8mm OD, T° range -20 to 100°C	
M-HB7	Metal pump inlet/outlet connector, hose barb 7mm, fits flexible tubing 7mm ID, T° range -40 to 120°C	
M-HB9	Metal pump inlet/outlet connector, hose barb 9mm, fits flexible tubing 9mm ID, T° range -40 to 120°C	
M-HB12	Metal pump inlet/outlet connector, hose barb 12mm, fits flexible tubing 12mm ID, T° range -40 to 120°C	
M-UC	Metal pump inlet/outlet plate, ¼" BSP/G1/4 female, T° range -50 to 200°C	

IQOQ LT ecocool100	IQOQ documentation for the LT ecocool100	
PQ LT ecocool100	PQ documentation for the LT ecocool100	

A full listing of product accessories and options is available in the Grant Scientific Reference Catalogue (a copy of which is available upon request) and on the Grant website at [www.grantinstruments.com](http://www.grantinstruments.com).

## 11.0 Troubleshooting

Symptom	Possible cause	Action required
Display shows "E07"	Refrigeration unit is not detected by control unit  Refrigeration unit has overheated	Check communications lead is connected to control and refrigeration units Check refrigeration unit is connected to mains power and switched on.  Wait for compressor to cool, when thermostat will reset and compressor will switch on again.  Remove any vent obstructions and carry out routine cleaning (see section 9.2)
Display shows "E01"	Refrigeration unit is connected but not powered	Check mains power to refrigeration unit.
Display shows "Hot"	Chiller in pre-over heating condition	Switch off unit. Check air vents are not restricted. Clean dust from condenser fins. See Section 9.
Display shows "UL"	Over-temperature cut-out has operated	Check the set temperature is correct and that the over-temperature cut-out temperature is set at least 5°C above the set temperature. Refer to section 5.2.7 for setting instructions.  If the over-temperature cut-out temperature is correctly set but the unit still shows a "Cut" alarm then the unit has an internal fault and must be repaired before it is used again.
Temperature does not rise when expected	Set temp is lower than liquid temp	Check that the bath set temperature is correct (see section 5.2.5).
Temp continues to rise when not expected	Set temp is higher than liquid temp	Check that the bath set temperature is correct (see section 5.2.5).
Display shows "ool"	Refrigeration unit has stopped cooling  Refrigeration unit has overheated	Check communications lead is connected to control and refrigeration units.  Switch off refrigeration unit and allow to cool
Alarm light on	Over-temperature cut-out has operated  Low liquid level float switch has operated	Check the over-temperature cut-out is set appropriately (see section 5.2.7).  Check that the liquid level in the bath is adequate.
Set temperature too restricted	Liquid type set does not allow required set point	Change to different liquid type (see section 5.3.5).

Display shows "FLot"	Liquid level has dropped below minimum level	Check that the liquid level in the bath is adequate.
Display shows "-RL-"	High temperature warning alarm has tripped	Check that the bath set temperature is correct (see section 5.2.3). Check that high temperature alarm is correct (section 5.3.4). Check that the liquid level in the bath is adequate (see section 6.3 for minimum fill levels).
Display shows "Er H"	Incorrect calibration value	The high temperature calibration point is less than 40°C above the low calibration point – choose a higher temperature (see section 5.2.10).
Display shows "Er L"	Incorrect calibration value	The low temperature calibration point is less than 40°C below the high calibration point – choose a lower temperature (see section 5.2.10).
Display shows "Er d"	Incorrect calibration value	The calibration value is greater than 10°C from the set point – check thermometer reading and set point (see section 5.2.10).
Display shows "OPEN"	Faulty internal temperature probe	Have a competent person check the probe for an open circuit fault or contact Grant.
Display shows "SHORT"	Faulty internal temperature probe	Have a competent person check the probe for a short circuit fault or contact Grant.
Unit showing erratic temperatures	Calibration values not set correctly	Restore the factory calibration settings (see section 5.2.11) then re-calibrate if required (see section 5.2.10).
Display shows "Hot"	Heating water at or near to boiling without lid  Heating very large volumes of liquid with large thermal losses	Fit a lid to reduce thermal losses and leave unit running with the "Hot" warning present. If the alarm has not cleared within 1 hour contact Grant.  Add measures to reduce thermal losses and leave unit running with the "Hot" warning present. If the alarm has not cleared within 1 hour contact Grant.
Display shows "Crct"	Internal PCB fault	Have a competent person check the product or contact Grant.
Display shows "SELF"	Internal heating circuit failure	Have a competent person check the product or contact Grant.
Stirrer motor not rotating	Stirring propeller or pump impeller is obstructed  Faulty motor	Clear obstruction.  Have a competent person check the motor or contact Grant.

Display shows “EOLd”	Accidentally entered manufacturer reset mode	Warning can be cleared by pressing <b>S</b> button, but note that all settings (including any factory calibration) will be reset to the default values. Contact Grant Instruments service department for assistance if required.
Display shows “FRct”	manufacturer factory setting menu	There are no user configuration options in this menu. Press the <b>F</b> button to return to the home screen
Display shows “????”	manufacturer factory setting menu	There are no user configuration options in this menu. Press the <b>F</b> button to return to the home screen

For any other errors or service requests, please contact Grant Instruments service department.



## 12.0 Contact Grant Instruments

---

At Grant we are continuously trying to improve the performance we offer our customers. If you have any feedback on Grant's products or services we would like to hear from you. Please send all feedback to:

Quality Manager  
Grant Instruments (Cambridge) Ltd  
Shepreth  
Cambridgeshire  
SG8 6GB  
UK

Tel: +44 (0) 1763 260 811  
Fax: +44 (0) 1763 262 410  
E-mail: [support@grantinstruments.com](mailto:support@grantinstruments.com)

## 13.0 Compliance

---

### WEEE directive

Grant Instruments complies fully with the Waste Electrical & Electronic Equipment (WEEE) regulations 2013. We are a member of the B2B compliance scheme (Scheme Approval Number WEE/MP3338PT/SCH), which handle our WEEE obligations on our behalf. Grant Instruments have been issued with a unique registration number by the Environmental Agency; this reference number is WEE/GA0048TZ.

For information regarding WEEE collections in the UK please contact our B2B Compliance Scheme directly on 01691 676 124.  
For other countries please contact your equipment supplier.

For General WEEE information please visit: [www.b2bcompliance.org.uk](http://www.b2bcompliance.org.uk)

### RoHS directive

All the products covered by this manual comply with the requirements of the RoHS Directive (2011/65/EU).

### Electrical safety and electromagnetic compatibility

All the products covered by this manual comply with the requirements of the Low Voltage Directive (2014/35/EU) for electrical safety and the EMC directive (2014/30/EU) for electromagnetic compatibility.

### Refrigerant and F-Gas regulations

The LT ecocool100 is hermetically sealed equipment containing HFC refrigerant R134a

Refrigerant charge: 0.14 Kg  
CO2 equivalent: 0.20 Tonnes  
Refrigerant must be disposed of according to local regulations

## Notes

---



# Grant

**Grant Instruments  
(Cambridge) Ltd**

Shepreth  
Cambridgeshire  
SG8 6GB  
UK

Tel: +44 (0) 1763 264 741

Fax: +44 (0) 1763 262 410

Email: [salesdesk@grantinstruments.com](mailto:salesdesk@grantinstruments.com)

[www.grantinstruments.com](http://www.grantinstruments.com)