

Contact Cadmus Products:  
+44(0)330 088 0595  
info@cadmus.co.uk  
Visit Website

**CARBOLITE**<sup>®</sup>  
**IGERO** 30-3000°C

## Laboratory Tube Furnaces

LEADING HEAT TECHNOLOGY



part of **VERDER**  
scientific

Contact Cadmus Products | +44(0)330 088 0595 | info@cadmus.co.uk



## SCIENCE FOR SOLIDS

**HEAT TREATMENT**  
**ELEMENTAL ANALYSIS**  
**MATERIALOGRAPHY &**  
**HARDNESS TESTING**  
**MILLING & SIEVING**  
**PARTICLE CHARACTERIZATION**

As part of the VERDER Group, the business division VERDER SCIENTIFIC sets standards in the development, manufacture and sales of laboratory and analytical equipment. The instruments are used in the areas of quality control, research and development for sample preparation and analysis of solids.

[www.verder-scientific.com](http://www.verder-scientific.com)

## Leading Heat Technology

The Carbolite Gero brand is synonymous with high quality, leading heat technology in the design and manufacture of laboratory and industrial ovens and furnaces ranging from 30°C to 3000°C and sold globally to over 100 countries.

On 1<sup>st</sup> January 2016 Carbolite (UK) and Carbolite Gero (Germany) joined to become one company under the name of Carbolite Gero. With the combined product lines the company will strengthen its market position locally and globally. In the past, both companies gained strong, established reputations for engineering expertise in applied heating technology.

Carbolite Gero has two manufacturing and sales sites. One is based in Derbyshire, United Kingdom, where Carbolite has been manufacturing laboratory and industrial ovens and furnaces up to 1800°C since 1938; the second facility is located in Neuhausen, southern Germany, where high temperature furnaces up to 3000°C with a large variety of solutions for vacuum and other modified atmospheres have been manufactured since 1982.

In addition to the wide range of standard products as shown in this catalogue, Carbolite Gero is an expert in the development of customized equipment for complex heat treatment processes. Solving customers' individual application requirements has given Carbolite Gero an important place in aerospace, engineering, materials science, heat treatment, medical, bioscience and contract testing laboratories globally to name a few. Not only can Carbolite Gero supply products with Standards-compliant furnace and oven designs (eg, Nadcap heat treatment processes (AMS2750E)), but also fully traceable certification for control, measurement, recording and data acquisition devices, issued by an independent UKAS accredited laboratory.

All products, and more, featured in this catalogue are available through your local Carbolite Gero office or an extensive network of dealers and local sales organisations.

[www.carbolite-gero.com](http://www.carbolite-gero.com)



## Content

	Model	up to	Page
<b>Tube Furnaces Selection Guide</b>			5
<b>Mounting Configurations</b>			6-7
<b>Tube Furnaces</b>			
Mini, Small, Medium Tube Furnaces	TF1, TF3	1200°C	8-11
Small, Medium, Large Split Tube Furnaces	TS1, TS3	1200°C	12-15
Horizontal and Vertical Tube Furnaces	FHA, FHC	1350°C	16-17
Horizontal and Vertical Split Tube Furnaces	FST, FZS	1300°C	18-19
Small, Medium Tube Furnaces, 1600°C	TF1, TF3	1600°C	20-21
High Temperature Horizontal Tube Furnaces	HTRH	1800°C	22-23
High Temperature Vertical Tube Furnaces	HTRV	1800°C	24-25
High Temperature Vertical Split Tube Furnaces	HTRV-A	1700°C	26-27
Graphite Tube Furnaces	HTRH-GR	2600°C	28-29
8-Zone Gradient Tube Furnaces	AZ	1350°C	31
Compact Gradient Split Tube Furnaces	TG2, TG3	1200°C	32-33
Rotary Reactor Tube Furnaces	HTR	1100°C	34
Rotating Horizontal Split Tube Furnaces	RHZS, RHST	1150°C	35
<b>Product Configurations</b>			
Temperature Control Options			36-40
Work Tube Selection Guide			41
Work Tube Packages			42-43
Work Tube Accessories			44-45
Vacuum Pump Packages			46
Inert gas packages			47
Laboratory gas safety system			48
Modified Atmosphere Options			49
<b>Power Supply Information</b>			50-51

### Disclaimer

As Carbolite Gero has a policy of continuous product development, improvements and changes will be made during the lifetime of this catalogue. Carbolite Gero reserves the right to amend the specifications at any time and in any particular way without prior notice provided that the ultimate performance of the equipment is not reduced by such action.

If the dimensions or technical specification of a product in this catalogue are critical, it is important that Carbolite Gero is contacted to confirm the details prior to order placement.



TF1 11/32/150 Mini



TS1 12/125/600 Medium



FHA 13/80/500



TF1 16/100/450 Medium



HTRV-A 17/100/700



HTRV 18/70/250



RHZS 11/75/900

HTR 11/150



With over 8 decades experience manufacturing universal and split-tube furnaces, Carbolite Gero is a global leader in the demanding area of temperature uniformity. A tube furnace is often selected as the most economical method of heating a small sample. Our latest power efficient tube furnace design significantly reduces the overall power consumption used in every cycle helping to improve your initial Return on Investment and ensuring you minimise your electricity costs.

Tube furnaces enable rapid temperature changes on the sample. They are available with single, three zone or gradient heating capabilities and can be configured with an inert atmosphere or a vacuum. Whatever your specific requirement we have a range of solutions that are highly configurable.

Carbolite Gero's design features optimised uniform zone

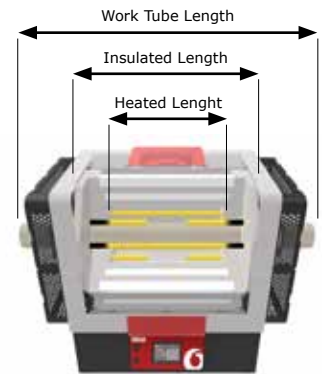

All Carbolite Gero tube furnaces have heating elements optimised for uniform temperature distribution.

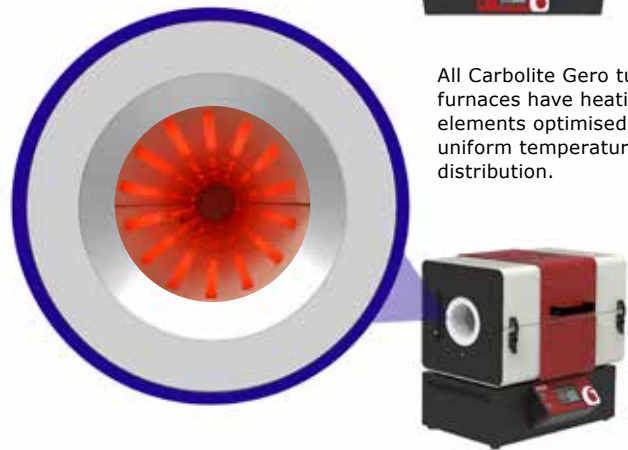

## The selection of a tube furnace should take into account the following factors:

### What temperature?

- It is recommended to allow at least 100 °C extra heating range above the desired working temperature
- Standard models are available with maximum operating temperatures from 1100 °C to 1800 °C

### Single or 3-zone?

- Tube furnaces provide a high level of uniformity which may be required for applications that require a specific temperature uniformity (see image top right showing typical optimised uniform length).
- The length of the central uniform zone can be further increased by adding heated zones at the ends in the form of a 3-zone furnace design
- For temperature gradients see page 30

### Size & work tubes?

- An accessory work tube is essential for tube furnaces
- To ensure the material properties are appropriate for the users application, accessory work tubes are available in a range of materials (see page 41)
- See the 'work tube package' section pages 42 – 43 for details of the available work tube package.

### Modified atmosphere or vacuum?

- Tube furnaces are ideal when the sample must be heated in an inert atmosphere or a vacuum
- Work tube packages for use with gas atmosphere and vacuum are available (pages 42 – 43)
- A choice of rotary vane or turbomolecular vacuum pump packages is available (see page 46)

## Temperature Uniformity Comparison

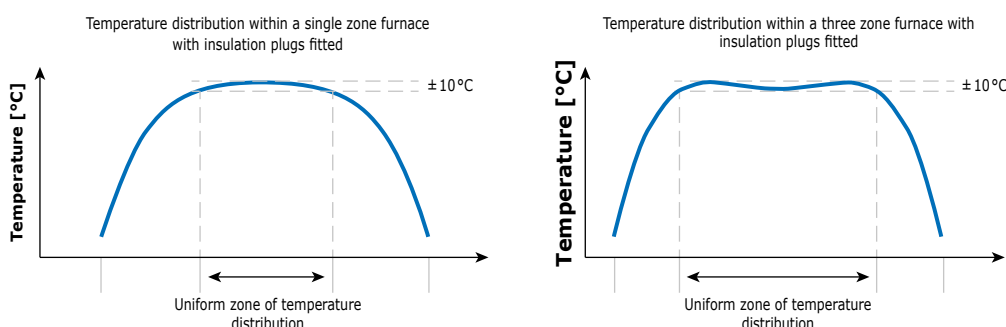

## Mounting Configurations

The Carbolite Gero TF, TS & TG tube furnaces are supplied in a horizontal configuration as standard.

The Carbolite Gero FHA, FHC, HTRH, HTRH-3, FST, FZS tube furnaces are supplied in a horizontal configuration as standard. The HTRH and HTRH-3 furnaces can not be tilted.

The Carbolite Gero HTRV and HTRV-A tube furnaces are supplied in a vertical configuration as standard and can not be tilted.

### Furnace body on top of control box

The following models have the furnace body mounted on top of the control box:

- TF mini;
- TF & TS small;
- TF & TS medium up to and including 600 mm heated length;
- TF 1600°C;
- TG small and medium.

The furnace body can be easily dismantled from the control box. The 2 m long interconnection cables that connect the furnace body to the control box can be easily unplugged.



TS small. Furnace body can be dismantled from the control box

### Furnace body and separate control box

The following models have a separate control box:

- TF & TS medium 800 mm heated length and above;
- TS large.
- FHA, FHC, FST & FZS
- HTRH & HTRH-3
- HTRV & HTRV-A



FHA 13/80/500 with optional CC-T1 controller and optional inert gas package



TS medium.  
1000 mm heated length

## Vertical packages

Optional 'vertical packages' can be ordered to mount the furnace body in a vertical orientation.

L-stands available for vertical use for FHA, FHC, FST, FZS tube furnaces.

Stands available for HTRV and HTRV-A tube furnaces as sole option and are part of inert gas packages with long work tube.



TS range with vertical stand package  
This includes the vertical tube support components



FHA, FHC, FST, FZS range with L-stand



HTRV range with stand and optional inert gas package



The base of the TS, TF & TG vertical stand package can be removed. The vertical frame can be used to mount the furnace to other equipment.



The vertical tube support package for TF, TS & TG without stand or mounting bracket is also available

### Interconnect cables

#### TF, TS & TG

The interconnection cables are 2 m long and can be easily unplugged. Optional 4 m extension leads are available to give a total of 6 m interconnection cable.

#### FHA, FHC, FST & FZS HTRH & HTRH-3 HTRV & HTRV-A

The interconnection cables are 3 m long and can be easily unplugged. Optional 6 m long interconnection cables are available.

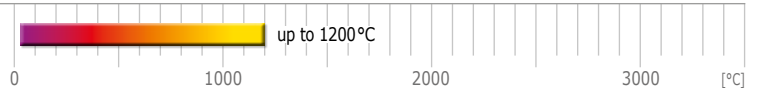

## TF1, TF3 Tube Furnaces

With maximum temperatures ranging from 1100 °C and 1200 °C, the TF tube furnace range incorporates high-quality heating elements and innovative thermal insulation design to achieve first class performance delivering both reduced case temperatures and power consumption.



TF1 11/32/150 with CC-T1 temperature programmer

### Standard features

- 1100 °C & 1200 °C maximum operating temperatures
- Programmable temperature controller with 24 segments.
  - TF1 fitted with Carbolite Gero EPC3016P1
  - TF3 fitted with Carbolite Gero CC-T1
- Ethernet Communications
- TF1 (1-zone) Heated length range from 150 to 1200 mm
- TF3 (3-zone) Heated length range from 450 to 1200 mm
- Accepts work tubes with outer diameters from 32 mm up to 125 mm
- Wire elements in high quality vacuum formed insulation ensure fast heat up, excellent temperature uniformity and short cool down times
- Horizontal configuration mounted on control module for heated lengths up to 600 mm
- Furnace body detachable from the control box to allow use of optional mounting arrangements (see pages 6–7)
- Horizontal configuration have a separate control module for heated lengths of 800 mm and above
- Control module with 2 metre cable to furnace with plug and socket

The extensive range features three main case sizes, mini, small, and medium, with multiple heated lengths available. Standard models can be configured to function with a single heated zone (TF1) or three heated zones (TF3) to extend the uniform heated length. Each heated zone of the TF3 benefits from its own dedicated controller and thermocouple.

A slide-in accessory work tube is required to protect the heating elements and support the work piece. The TF range can accommodate work tubes with outside diameters of 32 mm to 125 mm.

The variety of available work tubes and the use of tube adapters allow a single furnace to accommodate a variety of tube diameters. The work tubes themselves can easily be exchanged to meet the different physical or chemical requirements of a process.

Optional work tube packages enable users to equip the TF for operation under vacuum or modified atmosphere; for such applications, an extended work tube is required. Information can be found on pages 42–43.



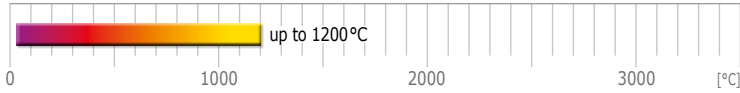

TF1 12/125/1000 with CC-T1 temperature programmer

- Low power consumption
- Optimised heating element positions
- Flexible mounting options
- Ethernet fitted as standard
- Temperature programmer as standard

### Options (specify these at time of order)

- A range of sophisticated digital controllers, multi-segment programmers and data loggers with digital communication options is available (see pages 36–40)
- Over-temperature protection (recommended to protect valuable contents & for unattended operation)
- A range of additional work tubes (page 41), end seals (page 44) and work tube packages (pages 42–43) is available for use with modified atmosphere and/or vacuum
- Vacuum packages with a choice of rotary vane pump or turbomolecular pump are available (page 46)
- Wide choice of tube diameters and materials is available. See page 41 for tube materials
- Insulation plugs and radiation shields to prevent heat loss and improve uniformity
- Vertical mounting stand for the furnace body including bracket for mounting the furnace body to customer's equipment
- 4 m long extension cable to give a total 6 m length of cable between furnace body and control box
- Gas packages with manual valve (page 47)
- Gas packages with electrically operated valve for up to 3 gases (page 47)



TF1 12/60/600 with CC-T1 temperature programmer and optional vertical package

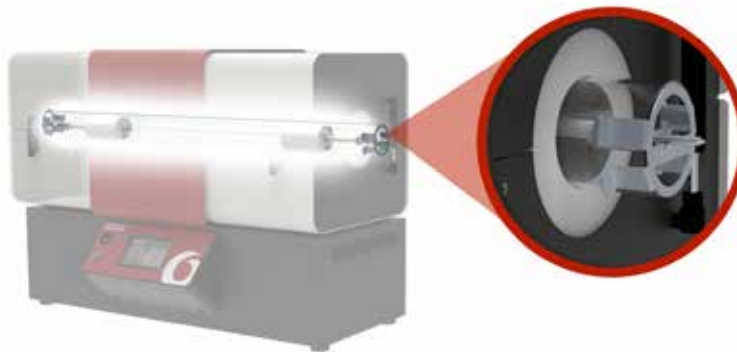
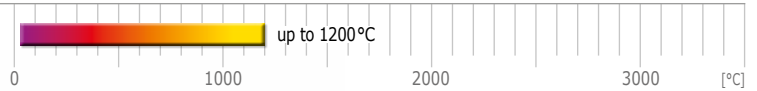

Detail showing the 'work tube package for air' installed in the furnace.

Work tube package for air shown with a TF1 12/60/600



Detail showing the work tube support bracket. Work tube packages with extended length work tubes include guards and support brackets as indicated in this image.

Work tube package for gas atmosphere shown with a TS1 12/60/600

## Technical data – TF1 Mini

Model	Max. temp. [°C]	Heat-up time [mins]	Dimensions: Max. outer Ø accessory tube [mm]	Dimensions: Heated length [mm]	Recommended tube length		Dimensions: Horizontal External H x W x D [mm]	Dimensions: control box H x W x D [mm]	Uniform length ±5°C [mm]	Max. power [W]	Holding power [W]	Thermocouple type	Weight [kg]
					for use in air [mm]	for use with modified atmosphere [mm]							
<b>TF1 11/32/150</b>	1100	27	32	150	300	500	445 x 335 x 470	220 x 335 x 450	58	575	230	K	15

**i** Please note:

- Heat up time is measured to 100°C below max, using an empty quartz tube & insulation plugs
- Heat up rate when using an optional ceramic work tube must be limited to 5°C/min
- Holding power is measured at continuous operating temperature

- Uniform temperature lengths are measured with insulation plugs fitted
- Maximum continuous operating temperature is 100°C below maximum temperature

## Technical data – TF1, TF3 Small

Model	Max. temp. [°C]	Heat up time [mins]	Dimensions: Max. outer Ø accessory tube [mm]	Dimensions: Heated length [mm]	Recommended tube length		Dimensions: Horizontal External H x W x D [mm]	Dimensions: control box H x W x D [mm]	Uniform length ±5°C [mm]	Max. power [W]	Thermocouple Type	Weight [kg]
					for use in air [mm]	for use with modified atmosphere [mm]						

### Single Zone Tube Furnaces TF1

<b>TF1 12/60/150</b>	1200	40	60	150	430	600	560 x 485 x 480	220 x 485 x 480	93	750	N	31
<b>TF1 12/60/300</b>	1200	35	60	300	580	750	560 x 495 x 480	220 x 485 x 480	177	1500	N	37
<b>TF1 12/60/450</b>	1200	45	60	450	730	900	560 x 645 x 480	220 x 635 x 480	318	2000	N	49
<b>TF1 12/60/600</b>	1200	45	60	600	880	1050	560 x 795 x 480	220 x 785 x 480	474	2500	N	56

### 3-Zone Tube Furnaces TF3

<b>TF3 12/60/450</b>	1200	55	60	450	730	900	560 x 645 x 480	220 x 635 x 480	340	2000	N	49
<b>TF3 12/60/600</b>	1200	55	60	600	880	1050	560 x 795 x 480	220 x 785 x 480	501	2500	N	56

**i** Please note:

- Heat up time is measured to 100°C below max, using an empty quartz tube & insulation plugs
- Heat up rate when using an optional ceramic work tube must be limited to 5°C/min
- Holding power is measured at continuous operating temperature

- Uniform temperature lengths are measured with insulation plugs fitted
- Maximum continuous operating temperature is 100°C below maximum temperature

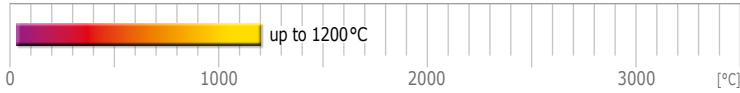

Work tube package for air + vertical stand and vertical tube support package shown with a TF1 12/60/600. Please see page 14 for detail images of the tube support package.



Work tube package for gas atmosphere + vertical stand and vertical tube support package shown with a TF1 12/125/400. Please see page 14 for detail images of the tube support package.

## Technical data – TF1, TF3 Medium

Model	Max. temp. [°C]	Heat-up time [mins]	Dimensions: Max. outer Ø accessory tube [mm]	Dimensions: Heated length [mm]	Recommended tube length		Dimensions: Horizontal External H x W x D [mm]	Dimensions: control box H x W x D [mm]	Uniform length ± 5°C [mm]	Max. power [W]	Holding power [W]	Thermocouple type	Weight [kg]
					for use in air [mm]	for use with modified atmosphere [mm]							

### Single Zone Tube Furnaces TF1

<b>TF1 12/125/400</b>	1200	88	125	400	750	1000	645 x 665 x 575	220 x 655 x 480	284	1860	1240	N	71
<b>TF1 12/125/600</b>	1200	90	125	600	950	1200	645 x 865 x 575	220 x 855 x 480	456	2510	1500	N	89
<b>TF1 12/125/800</b>	1200	85	125	800	1150	1400	430 x 1065 x 575	220 x 655 x 480*	635	3160	1800	N	102
<b>TF1 12/125/1000</b>	1200	80	125	1000	1350	1600	430 x 1265 x 575	220 x 655 x 480*	847	3810	2100	N	120
<b>TF1 12/125/1200</b>	1200	82	125	1200	1550	1800	430 x 1465 x 575	220 x 655 x 480*	969	4460	2400	N	134

### 3-Zone Tube Furnaces TF3

<b>TF3 12/125/600</b>	1200	90	125	600	950	1200	645 x 865 x 575	220 x 855 x 480	507	2510	1500	N	89
<b>TF3 12/125/800</b>	1200	85	125	800	1150	1400	430 x 1065 x 575	220 x 655 x 480*	715	3160	1800	N	102
<b>TF3 12/125/1000</b>	1200	80	125	1000	1350	1600	430 x 1265 x 575	220 x 655 x 480*	855	3810	2100	N	120
<b>TF3 12/125/1200</b>	1200	82	125	1200	1550	1800	430 x 1465 x 575	220 x 655 x 480*	1055	4460	2400	N	134

**i** Please note:

- Heat up time is measured to 100°C below max, using an empty quartz tube & insulation plugs
- Heat up rate when using an optional ceramic work tube must be limited to 5°C/min
- Holding power is measured at continuous operating temperature

- Uniform temperature lengths are measured with insulation plugs fitted
- Maximum continuous operating temperature is 100°C below maximum temperature
- \* Furnace with separate control box

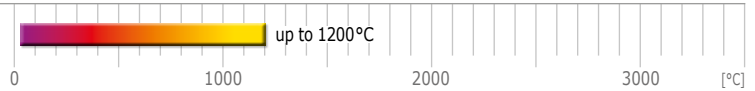

## TS1, TS3 Split Tube Furnaces

**With a maximum temperature of 1200 °C, the TS tube furnace range incorporates high-quality heating elements and innovative thermal insulation design to achieve first class performance delivering both reduced case temperatures and power consumption.**

The extensive range features three main case sizes, small, medium and large, with multiple heated lengths available. Standard models can be configured to function with a single heated zone (TS1) or three heated zones (TS3) to extend the uniform heated length. Each heated zone of the TS3 benefits from its own dedicated controller and thermocouple.

The TS furnace body is split into two halves and hinged at the rear; pneumatic dampening struts at either end provide a smooth opening action. The ability to open the furnace makes it easier for operators to exchange work tubes, or insert vessels, such as reactors, with end flanges that would make them difficult to insert into a non-split furnace.

An accessory work tube is required to protect the heating elements and support the work piece. The TS range can accommodate work tubes with outside diameters ranging from 60 mm to 200 mm.



TS1 12/125/600 with CC-T1 temperature programmer

Slide-in accessory work tubes and the use of tube adapters allow a single furnace to accommodate a variety of tube diameters. The work tubes themselves can easily be exchanged to meet the different physical or chemical requirements of a process.

Optional work tube packages enable users to equip the TS for operation under vacuum or modified atmosphere; for such applications, an extended work tube is required. Information can be found on pages 42–43.

### Standard features

- 1200 °C maximum operating temperature
- Programmable temperature controller with 24 segments.
  - TS1 fitted with Carbolite Gero EPC3016P1
  - TS3 fitted with Carbolite Gero CC-T1
- TS1 (1-zone) Heated length range from 150 to 1200 mm
- TS3 (3-zone) Heated length range from 450 to 1200 mm
- Accepts work tubes with outer diameters from 60 mm up to 200 mm
- Wire elements in high quality vacuum formed insulation ensure fast heat up, excellent temperature uniformity and short cool down times
- Furnace splits into two halves and accommodates tubes or samples fixed into a test rig
- Horizontal configuration mounted on control module for heated lengths up to 600 mm
- Furnace body detachable from the control box to allow use of optional mounting arrangements (see page 6–7)
- Horizontal configuration have a separate control module for heated lengths of 800 mm and above
- Control module with 2 metre cable to furnace with plug and socket



TS1 12/125/600 with CC-T1 temperature programmer

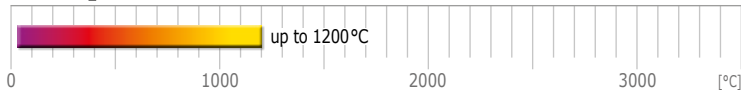

TS1 12/60/150 with CC-T1 and optional vertical package



TS1 12/200/600 with CC-T1 temperature programmer

### Options (specify these at time of order)

- A range of sophisticated digital controllers, multi-segment programmers and data loggers with digital communication options is available (see pages 36–40)
- Over-temperature protection (recommended to protect valuable contents & for unattended operation)
- A range of additional work tubes (page 41), end seals (page 44) and work tube packages (pages 42–43) is available for use with modified atmosphere and/or vacuum
- Vacuum packages with a choice of rotary vane pump or turbomolecular pump are available (page 46)
- Wide choice of tube diameters and materials is available. See page 41 for tube materials
- Insulation plugs and radiation shields to prevent heat loss and improve uniformity
- Vertical mounting stand for the furnace body including bracket for mounting the furnace body to customer's equipment
- 4 m long extension cable to give a total 6 m length of cable between furnace body and control box
- Gas packages with manual valve (page 47)
- Gas packages with electrically operated valve for up to 3 gases (page 47)



TS1 12/60/150 with CC-T1 temperature programmer



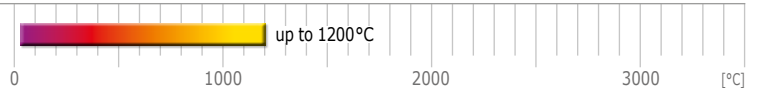

Work tube package for air + vertical stand and vertical tube support package shown with a TS1 12/60/600



Detail showing work tube guiding bracket. This is supplied with the vertical tube support package.

Detail showing the lower work tube support clamp. This is supplied with the vertical tube support package.



Work tube package for gas atmosphere + vertical stand and vertical tube support package shown with a TS1 12/125/400



Detail showing work tube guiding bracket. This is supplied with the vertical tube support package.

Detail showing the lower work tube support clamp. This is supplied with the vertical tube support package.

## Technical data – TS1, TS3 Small

Model	Max. temp. [°C]	Heat-up time [mins]	Dimensions: Max. outer $\phi$ accessory tube [mm]	Dimensions: Heated length [mm]	Recommended tube length		Dimensions: Horizontal External H x W x D [mm]	Dimensions: control box H x W x D [mm]	Uniform length $\pm 5^\circ\text{C}$ [mm]	Max. power [W]	Thermo-couple Type	Weight [kg]
					for use in air [mm]	for use with modified atmosphere [mm]						

### Single Zone Split Tube Furnaces TS1

<b>TS1 12/60/150</b>	1200	99	60	150	430	600	560 x 485 x 480 (closed) 765 x 485 x 530 (open)	220 x 485 x 480	77	750	N	31
<b>TS1 12/60/300</b>	1200	46	60	300	580	750	560 x 495 x 480 (closed) 765 x 495 x 530 (open)	220 x 485 x 480	-	1500	N	37
<b>TS1 12/60/450</b>	1200	-	60	450	730	900	560 x 645 x 480 (closed) 765 x 645 x 530 (open)	220 x 635 x 480	-	2000	N	49
<b>TS1 12/60/600</b>	1200	-	60	600	880	1050	560 x 795 x 480 (closed) 765 x 795 x 530 (open)	220 x 785 x 480	-	2500	N	56

### 3-Zone Split Tube Furnaces TS3

<b>TS3 12/60/450</b>	1200	-	60	450	730	900	560 x 645 x 480 (closed) 765 x 645 x 530 (open)	220 x 635 x 480	-	2000	N	49
<b>TS3 12/60/600</b>	1200	63	60	600	880	1050	560 x 795 x 480 (closed) 765 x 795 x 530 (open)	220 x 785 x 480	-	2500	N	56

**i** Please note:

- Heat up time is measured to 100°C below max, using an empty quartz tube & insulation plugs
- Heat up rate when using an optional ceramic work tube must be limited to 5°C/min
- Holding power is measured at continuous operating temperature

- Uniform temperature lengths are measured with insulation plugs fitted
- Maximum continuous operating temperature is 100°C below maximum temperature

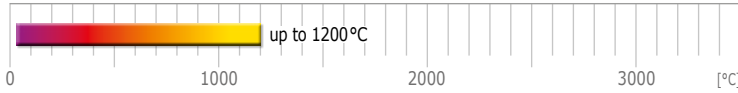

## Technical data – TS1, TS3 Medium

Model	Max. temp. [°C]	Heat-up time [mins]	Dimensions: Max. outer Ø accessory tube [mm]	Dimensions: Heated length [mm]	Recommended tube length		Dimensions: Horizontal External H x W x D [mm]	Dimensions: control box H x W x D [mm]	Max. power [W]	Holding power [W]	Thermo-couple type	Weight [kg]
					for use in air [mm]	for use with modified atmosphere [mm]						

### Single Zone Split Tube Furnaces TS1

<b>TS1 12/125/400</b>	1200	134	125	400	750	1000	645 x 665 x 575 (closed) 905 x 665 x 655 (open)	220 x 655 x 480	1860	1100	N	71
<b>TS1 12/125/600</b>	1200	150	125	600	950	1200	645 x 865 x 575 (closed) 905 x 865 x 655 (open)	220 x 855 x 480	2510	1450	N	89
<b>TS1 12/125/800</b>	1200	147	125	800	1150	1400	430 x 1065 x 575 (closed) 690 x 1065 x 655 (open)	220 x 655 x 480*	3160	1600	N	102
<b>TS1 12/125/1000</b>	1200	147	125	1000	1350	1600	430 x 1265 x 575 (closed) 690 x 1265 x 655 (open)	220 x 655 x 480*	3810	1900	N	120
<b>TS1 12/125/1200</b>	1200	154	125	1200	1550	1800	430 x 1465 x 575 (closed) 690 x 1465 x 655 (open)	220 x 655 x 480*	4460	2350	N	134

### 3-Zone Split Tube Furnaces TS3

<b>TS3 12/125/600</b>	1200	113	125	600	950	1200	645 x 865 x 575 (closed) 905 x 865 x 655 (open)	220 x 855 x 480	2510	1450	N	89
<b>TS3 12/125/800</b>	1200	141	125	800	1150	1400	430 x 1065 x 575 (closed) 690 x 1065 x 655 (open)	220 x 655 x 480*	3160	1600	N	102
<b>TS3 12/125/1000</b>	1200	134	125	1000	1350	1600	430 x 1265 x 575 (closed) 690 x 1265 x 655 (open)	220 x 655 x 480*	3810	1900	N	120
<b>TS3 12/125/1200</b>	1200	138	125	1200	1550	1800	430 x 1465 x 575 (closed) 690 x 1465 x 655 (open)	220 x 655 x 480*	4460	2350	N	134

**i** Please note:

- Heat up time is measured to 100°C below max, using an empty quartz tube & insulation plugs
- Heat up rate when using an optional ceramic work tube must be limited to 5°C/min
- Holding power is measured at continuous operating temperature

- Uniform temperature lengths are measured with insulation plugs fitted
- Maximum continuous operating temperature is 100°C below maximum temperature
- \* Furnace with separate control box

## Technical data – TS1, TS3 Large

Model	Max. temp. [°C]	Heat-up time [mins]	Dimensions: Max. outer Ø accessory tube [mm]	Dimensions: Heated length [mm]	Recommended tube length		Dimensions: Horizontal External H x W x D [mm]	Dimensions: control box H x W x D [mm]	Max. power [W]	Holding power [W]	Thermo-couple type	Weight [kg]
					for use in air [mm]	for use with modified atmosphere [mm]						

### Single Zone Split Tube Furnaces TS1

<b>TS1 12/200/600</b>	1200	62	200	600	1300	1300	530 x 1015 x 670 (closed) 845 x 1015 x 760 (open)	220 x 655 x 480*	6600	3400	N	127
<b>TS1 12/200/1200</b>	1200	80	200	1200	1900	1900	530 x 1615 x 670 (closed) 845 x 1615 x 760 (open)	220 x 1255 x 480*	11400	3800	N	192

### 3-Zone Split Tube Furnaces TS3

<b>TS3 12/200/600</b>	1200	62	200	600	1300	1300	530 x 1015 x 670 (closed) 845 x 1015 x 760 (open)	220 x 655 x 480*	6600	3400	N	127
<b>TS3 12/200/1200</b>	1200	80	200	1200	1900	1900	530 x 1615 x 670 (closed) 845 x 1615 x 760 (open)	220 x 1255 x 480*	11400	3800	N	192

**i** Please note:

- Heat up time is measured to 100°C below max, using an empty quartz tube & insulation plugs
- Heat up rate when using an optional ceramic work tube must be limited to 5°C/min
- Holding power is measured at continuous operating temperature

- Uniform temperature lengths are measured with insulation plugs fitted
- Maximum continuous operating temperature is 100°C below maximum temperature
- \* Furnace with separate control box

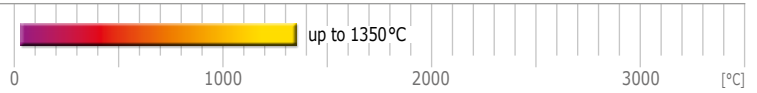

## FHA, FHC – Horizontal and Vertical Tube Furnaces

**The FHA, single zone, and FHC, 3-zone, tube furnaces can be used either vertically or horizontally and have a maximum operating temperature of 1350°C.**

The extensive F range of tube furnaces is offered with a wide range of accessories. The furnaces comprise ceramic fibre modules with a high quality 5 mm APM wire heating element mounted in the insulation, held in position by a ceramic holding ridge. The low thermal mass ceramic fibre insulation ensures low energy consumption and allows fast heating rates. The control thermocouple is a high grade type S thermocouple. Additionally, the tube furnace is available with up to 8 heating zones for the most precise temperature control and uniformity.

### Standard features

- 1350°C maximum operating temperature
- Programmable temperature controller with 24 segments.
  - FHA fitted with Carbolite Gero EPC3016P1
  - FHC fitted with Carbolite Gero CC-T1
- Over-temperature controller with independent thermocouple
- Accepts work tubes with outer diameters up to 110 mm
- Heated lengths of 200, 500, 750, 1000 or 1250 mm
- Use in horizontal or vertical orientation
- Exceptional lifetime and temperature stability
- High grade thermocouple type S
- Low thermal mass ceramic fibre insulation
- High quality 5 mm APM wire heating element
- Furnace fitted with separate control box with 3 m cable, plug and socket
- **NEW** Ethernet communications

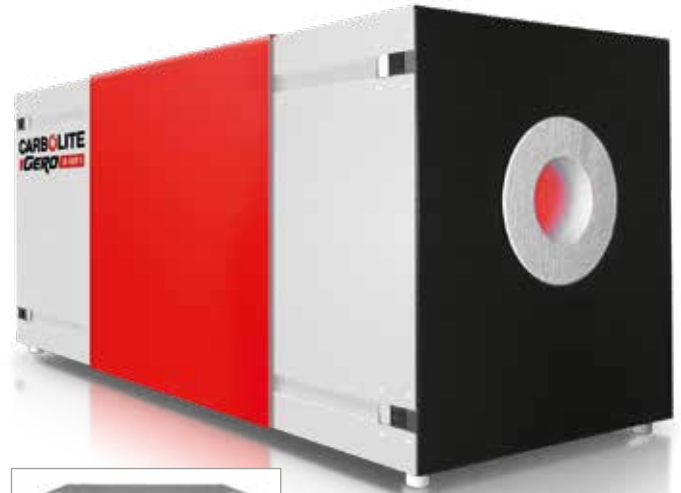

FHA 13/80/500



Control module with optional CC-T1 touchscreen programmer

### Options (specify these at time of order)

- A range of sophisticated digital controllers, multisegment programmers and data loggers with digital communication options is available (see pages 36–40)
- Wide choice of tube diameters and materials is available. See page 41 for tube materials
- 'L' stand for vertical usage
- Insulation plugs & radiation shields to prevent heat loss & improve uniformity (see page 45)
- Modified atmosphere and vacuum assemblies are available (see page 45)
- Larger tube diameters on request
- Vacuum packages with a choice of rotary vane pump or turbomolecular pump are available (page 46)
- Oxygen sensor for inert gas packages
- 6 m length of cable between furnace body and control box with plug and socket



FHA 13/110/1000 with optional basic inert gas package and optional L-stand

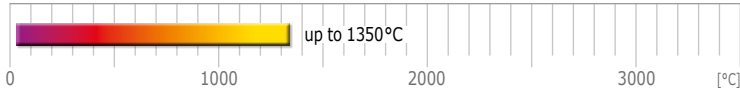

FHA 13/80/500 with optional CC-T1 controller, voltage/current display and high vacuum capable inert gas package. Rotary vane pumps and turbo pumps available (see page 46)

## Technical data

Tube furnace FHA (single zone) and FHC (three zones) both available in horizontal and vertical arrangement (with optional 'L' stand)

Model	Max. temp. [°C]	Dimensions: Max. outer Ø accessory tube [mm]	Dimensions: Heated length [mm]	Recommended tube length		Dimensions: External furnace H x W x D [mm]	Furnace weight [kg]	Dimensions: Control module H x W x D* [mm]	Control module weight [kg]	Uniform length ± 5°C [mm]	Max. power [W]
				for use in air [mm]	for use with modified atmosphere [mm]						

### Horizontal and Vertical Tube Furnaces (may need further equipment) FHA

FHA 13/32/200	1350	32	200	390	925	420 x 400 x 350	25	480 x 560 x 500	50	100	1200
FHA 13/32/500	1350	32	500	690	1225	420 x 700 x 350	30	480 x 560 x 500	50	250	2400
FHA 13/50/200	1350	50	200	390	925	420 x 400 x 350	30	480 x 560 x 500	50	100	1500
FHA 13/50/500	1350	50	500	690	1225	420 x 700 x 350	35	480 x 560 x 500	50	250	3600
FHA 13/50/750	1350	50	750	940	1475	420 x 950 x 350	40	850 x 560 x 500	60	375	5400
FHA 13/80/200	1350	80	200	390	925	420 x 400 x 350	35	480 x 560 x 500	50	100	2100
FHA 13/80/500	1350	80	500	690	1225	420 x 700 x 350	40	480 x 560 x 500	60	200	5200
FHA 13/80/750	1350	80	750	940	1475	420 x 950 x 350	50	850 x 560 x 500	70	375	7800
FHA 13/80/1000	1350	80	1000	1190	1725	420 x 1200 x 350	80	850 x 560 x 500	90	500	10400
FHA 13/110/500	1350	110	500	690	1225	590 x 700 x 520	55	850 x 560 x 500	70	250	7800
FHA 13/110/750	1350	110	750	940	1475	590 x 950 x 520	70	850 x 560 x 500	90	375	11500
FHA 13/110/1000	1350	110	1000	1190	1725	590 x 1200 x 520	100	1100 x 1200 x 700	90	500	16000
FHA 13/110/1250	1350	110	1250	1440	1975	590 x 1450 x 520	130	1100 x 1200 x 700	90	610	20000

### 3-Zone Horizontal and Vertical Tube Furnaces (may need further equipment) FHC

FHC 13/32/500	1350	32	500	690	1225	420 x 700 x 350	30	480 x 560 x 500	50	350	2400
FHC 13/50/500	1350	50	500	690	1225	420 x 700 x 350	35	480 x 560 x 500	50	350	3600
FHC 13/50/750	1350	50	750	940	1475	420 x 950 x 350	40	850 x 560 x 500	60	550	5400
FHC 13/80/500	1350	80	500	690	1225	420 x 700 x 350	40	480 x 560 x 500	60	350	5200
FHC 13/80/750	1350	80	750	940	1475	420 x 950 x 350	50	850 x 560 x 500	70	550	7800
FHC 13/80/1000	1350	80	1000	1190	1725	420 x 1200 x 350	80	850 x 560 x 500	90	800	10400
FHC 13/110/500	1350	110	500	690	1225	590 x 700 x 520	55	850 x 560 x 500	70	300	7800
FHC 13/110/750	1350	110	750	940	1475	590 x 950 x 520	70	850 x 560 x 500	90	500	11500
FHC 13/110/1000	1350	110	1000	1190	1725	590 x 1200 x 520	100	1100 x 1200 x 700	90	750	16000
FHC 13/110/1250	1350	110	1250	1440	1975	590 x 1450 x 520	130	1100 x 1200 x 700	90	950	20000

**i** Please note:

- Heat up rate when using an optional ceramic work tube must be limited to 5°C/min
- \* Further to the depth of the control module 150 mm for the power plugs and other plugs needs to be added

- The power supply is based on 200 – 240 V for 1 phase and 380 – 415 V for 3 phase power
- Minimum uniform length in horizontal furnace with insulation plugs fitted at 100°C below max. temperature

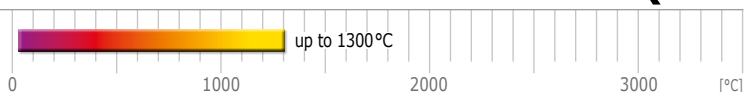

## FST, FZS – Horizontal and Vertical Split Tube Furnaces

**The FST, single zone, and FZS, 3-zone, split tube furnaces can be used either vertically or horizontally and have a maximum operating temperature of 1300°C.**

The split heating module allows either easy positioning of the work tube or positioning around reactors which have fixed end flanges. The split design may also allow faster cooling of the sample. Cooling channels are engineered into the housing to aid with convection cooling of the outer case. A handle is attached to the upper half of the split tube furnace with two quick-release clamps to safely unlock and lock the furnace. The two furnace halves are ceramic fibre modules with high quality APM wire heating elements mounted in the insulation, held in position by a ceramic holding ridge. A safety switch protects the operator by switching off the heating elements once the furnace is opened.



FST 13/70/500  
with optional  
CC-T1 controller



Control module with  
optional CC-T1 touchscreen  
programmer

### Standard features

- 1300°C maximum operating temperature
- Programmable temperature controller with 24 segments.
  - FST fitted with Carbolite Gero EPC3016P1
  - FZS fitted with Carbolite Gero CC-T1
- Over-temperature controller with independent thermocouple
- Accepts work tubes with outer diameter up to 150 mm
- Single-zone heated lengths of 200, 500 or 1000 mm
- 3-zone heated lengths of 500 or 1000 mm
- Split design allows work tubes or reactors with fixed flanges to be accommodate
- For horizontal or vertical use
- Exceptionally long life time and temperature stability
- High grade type S thermocouple
- Low thermal mass ceramic fibre insulation
- High quality 5 mm APM wire heating elements
- Supplied with separate control box with 3 m cable, plug and socket
- **NEW** Ethernet communications

### Options (specify these at time of order)

- A range of sophisticated digital controllers, multisegment programmers and data loggers with digital communication options is available (see pages 36–40)
- Wide choice of tube diameters and materials is available. See page 41 for tube materials
- For split tube furnaces, robustly shaped ceramic half tubes are available to protect the heating elements and for sample holding
- 'L' stand for vertical and/or horizontal use
- Insulation plugs & radiation shields to prevent heat loss & improve uniformity (see page 45)
- Modified atmosphere and vacuum packages are available (see page 45)
- Vacuum packages with a choice of rotary vane pump or turbomolecular pump are available (page 46)
- Larger tube diameters
- Longer heated lengths
- Automated opening mechanism
- Flanges for inert gas counter flow
- Oxygen sensor for inert gas packages
- 6 m length of cable between furnace body and control box with plug and socket
- Gas packages with manual valve (page 47)
- Gas packages with electrically operated valve for up to 3 gases (page 47)



Custom designed 3-zone FZS 13/100/4500 with 4500 mm heated length, automated opening and APM work tube



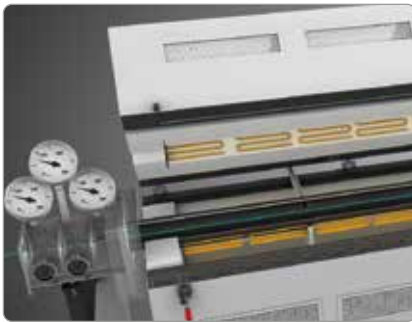
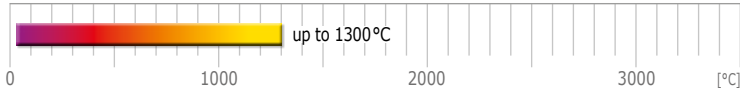

Interior view of custom designed FZS with flanges for inert gas counter flow for open operation during inert gas heat treatment



Custom designed 6-zone FZS 13/100/3000 with 3000 mm heated length and counter flow flanges. For simultaneous heat treatment of four carbon fibres under inert gas atmosphere. Supplied with separate control cabinet.

## Technical data

Model	Max. temp. [°C]	Dimensions: Max. outer Ø accessory tube [mm]	Dimensions: Heated length [mm]	Recommended tube length		Dimensions: External furnace H x W x D [mm]	Furnace weight [kg]	Dimensions: Control module H x W x D* [mm]	Control module weight [kg]	Uniform length ± 5°C [mm]	Max. power [W]
				for use in air [mm]	for use with modified atmosphere [mm]						

### Single Zone Horizontal and Vertical Split Tube Furnaces FST (may need further equipment)

<b>FST 13/40/200</b>	1300	40	200	450	985	530 x 460 x 560	35	480 x 560 x 500	50	100	1500
<b>FST 13/70/500</b>	1300	70	500	670	1205	530 x 680 x 560	50	480 x 560 x 500	50	250	3000
<b>FST 13/100/500</b>	1300	100	500	670	1205	530 x 680 x 560	75	850 x 560 x 500	60	250	4000
<b>FST 13/100/1000</b>	1300	100	1000	1190	1725	530 x 1200 x 560	80	850 x 560 x 500	90	500	10400
<b>FST 13/150/1000</b>	1300	150	1000	1190	1725	590 x 1200 x 560	100	850 x 560 x 500	90	500	12000

### 3-Zone Horizontal and Vertical Split Tube Furnaces FZS (may need further equipment)

<b>FZS 13/70/500</b>	1300	70	500	670	1205	530 x 680 x 560	50	480 x 560 x 500	50	350	3000
<b>FZS 13/100/500</b>	1300	100	500	670	1205	530 x 680 x 560	75	850 x 560 x 500	60	300	4000
<b>FZS 13/100/1000</b>	1300	100	1000	1190	1725	530 x 1200 x 560	80	1100 x 1200 x 700	90	800	10400
<b>FZS 13/150/1000</b>	1300	150	1000	1190	1725	590 x 1200 x 560	100	1100 x 1200 x 700	90	600	12000
<b>FZS 13/200/1000</b>	1300	200	1000	1190**	1725**	690 x 1200 x 620	150	1100 x 1200 x 700	120		16000

### 3-Zone Horizontal Split Tube Furnaces FZS (may need further equipment)

<b>FZS 13/100/1500</b>	1300	100	1500	1690	2225	530 x 1700 x 560	120	1100 x 1200 x 700	120		14000
<b>FZS 13/100/4500</b>	1300	100	4500	on request	on request	2200 x 4700 x 1100	800	inside frame	-		45000
<b>FZS 13/150/1500</b>	1300	150	1500	1690**	2225**	590 x 1700 x 560	150	1100 x 1200 x 700	120		18000
<b>FZS 13/150/4500</b>	1300	150	4500	on request	on request	2200 x 4700 x 1200	950	inside frame	-		60000
<b>FZS 13/200/1500</b>	1300	200	1500	1690**	2225**	690 x 1700 x 620	200	1100 x 1200 x 700	160		22000

**i** Please note:

- Heat up rate when using an optional ceramic work tube must be limited to 5°C/min
- The power supply is based on 200–240 V for 1 phase and 380–415 V for 3 phase power
- Minimum uniform length in horizontal furnace with insulation plugs fitted at 100°C below max. temperature

- \* Further to the depth of the control module 150 mm for the power plugs and other plugs needs to be added
- \*\* (APM or quartz)

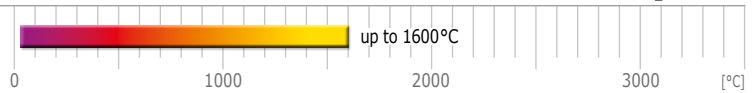

## TF1, TF3 Tube Furnaces, 1600 °C

**The TF tube furnaces achieve first class performance with low power consumption and low case temperature due to the use of high-quality heating elements and thermal insulation design. Maximum temperature of 1600 °C is available.**

The range includes small and medium case sizes and two heated lengths in each size. The TF1 are single zone furnaces and the TF3 are three zone furnaces which further extend the uniform heated length.

Work tubes with outside diameters of 60 mm and 100 mm can be fitted. The use of an accessory slide-in work tube protects the heating element and is required to support the work piece.

The 3-zone TF3 furnaces provide excellent temperature uniformity resulting from division of the heated length into 3-zones with its own controller and thermocouple.

Should vacuum or a modified atmosphere be required, it is necessary to use a slide-in work tube of adequate length needed to fit end seals. In some circumstances a work tube that has different physical or chemical properties may be required. This information can be found on page 41. The benefit of this design is its flexibility; with the use of tube adapters the same furnace can be used with a variety of tube diameters.



TF1 16/60/300 with CC-T1 temperature programmer



TF1 16/100/450 with vertical package

### Standard features

- 1600 °C maximum operating temperature
- Programmable temperature controller with 24 segments.
  - TF1 fitted with Carbolite Gero EPC3016P1
  - TF3 fitted with Carbolite Gero CC-T1
- Over temperature controller with independent thermocouple
- Ethernet Communications
- TF1 (1-zone) Heated length range from 180 to 600 mm
- TF3 (3-zone) Heated lengths of 450 and 600 mm
- Accepts work tubes with outer diameters from 60 mm up to 100 mm
- Silicon carbide elements ensure fast heat up and excellent temperature uniformity
- Horizontal configuration mounted on control module
- Furnace body detachable from the control box to allow use of optional mounting arrangements (see pages 6–7)
- Control module with 2 metre cable to furnace with plug and socket

### Options (specify these at time of order)

- A range of sophisticated digital controllers, multi-segment programmers and data loggers with digital communication options is available (see pages 36–40)
- A range of additional work tubes (page 41), end seals (page 44) and work tube packages (pages 42–43) is available for use with modified atmosphere and/or vacuum
- Vacuum packages with a choice of rotary vane pump or turbomolecular pump are available (page 46)
- Wide choice of tube diameters and materials is available. See page 41 for tube materials
- Insulation plugs and radiation shields to prevent heat loss and improve uniformity
- Vertical mounting stand for the furnace body including bracket for mounting the furnace body to customer's equipment
- 4 m long extension cable to give a total 6 m length of cable between furnace body and control box
- Gas packages with manual valve (page 47)
- Gas packages with electrically operated valve for up to 3 gases (page 47)

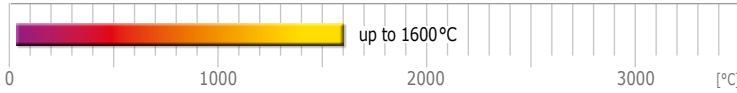

## View inside

- 1 Centre zone heating element
- 2 End zone heating elements
- 3 Thermal insulation
- 4 3-zone temperature control
- 5 Work tube

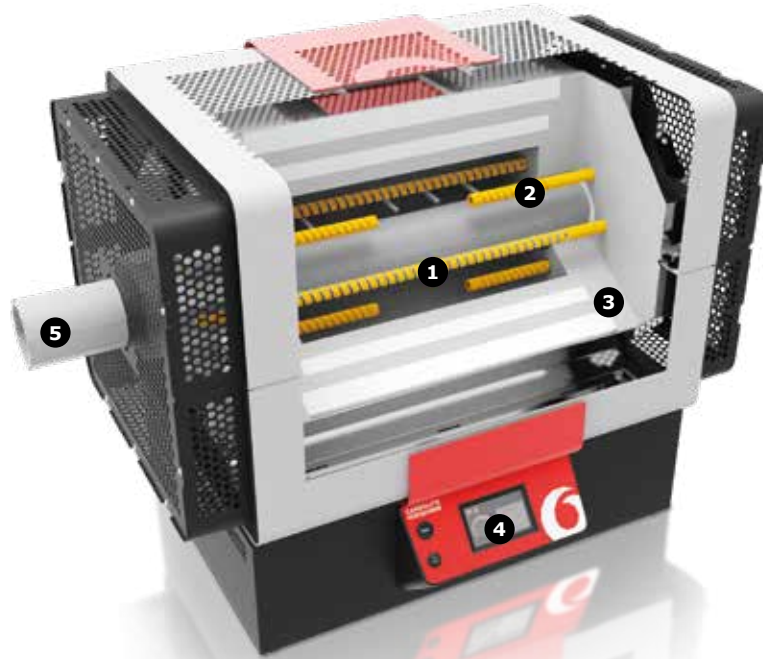

TF3 16/100/450 with CC-T1 controller

## Technical data – TF1 1600 °C Small

Model	Max. temp. [°C]	Dimensions: Max. outer Ø accessory tube [mm]	Dimensions: Heated length [mm]	Recommended tube length		Dimensions: External H x W x D [mm]	Uniform length ± 5°C [mm]	Max. power [W]	Holding power [W]	Thermo-couple type	Weight [kg]
				for use in air [mm]	for use with modified atmosphere [mm]						

### Single Zone High Temperature Tube Furnaces TF1 Small

<b>TF1 16/60/180</b>	1600	60	180	680	900	650 x 595 x 585	100	2500	1300	R	43
<b>TF1 16/60/300</b>	1600	60	300	800	1020	650 x 715 x 585	175	4000	1600	R	51

## Technical data – TF1, TF3 1600 °C Medium

Model	Max. temp. [°C]	Dimensions: Max. outer Ø accessory tube [mm]	Dimensions: Heated length [mm]	Recommended tube length		Dimensions: External H x W x D [mm]	Uniform length ± 5°C [mm]	Max. power [W]	Holding power [W]	Thermo-couple type	Weight [kg]
				for use in air [mm]	for use with modified atmosphere [mm]						

### Single Zone High Temperature Tube Furnaces TF1 Medium

<b>TF1 16/100/450</b>	1600	100	450	1030	1250	775 x 940 x 705	-	6000	-	R	90
<b>TF1 16/100/600</b>	1600	100	600	1180	1400	775 x 1090 x 705	425	7000	3700	R	100

### 3-Zone High Temperature Tube Furnaces TF3

<b>TF3 16/100/450</b>	1600	100	450	1030	1250	775 x 940 x 705	375	6800	-	R	90
<b>TF3 16/100/600</b>	1600	100	600	1180	1400	775 x 1090 x 705	460	8000	3700	R	100

**i** Please note:

- Heat up time is measured to 100°C below max, using an empty quartz tube & insulation plugs
- Heat up rate when using an optional ceramic work tube must be limited to 5°C/min
- Holding power is measured at continuous operating temperature

- Uniform temperature lengths are measured with insulation plugs fitted
- Maximum continuous operating temperature is 100°C below maximum temperature

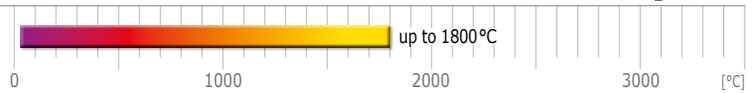

## HTRH – High Temperature Horizontal Tube Furnaces

**The Carbolite Gero high temperature tube furnaces HTRH can be used horizontally up to 1800°C.**

The high-grade insulation materials guarantee low energy consumption and high heating rates due to their low thermal conductivity. The insulation and molybdenum disilicide ( $\text{MoSi}_2$ ) heating elements are installed in the rectangular housing. The heating elements are vertically hanging (see 'view inside' figure) and can be replaced easily. At higher temperatures and in the presence of oxygen,  $\text{MoSi}_2$  develops an oxide ( $\text{SiO}_2$ ) layer, which protects the heating elements against further thermal or chemical corrosion.

### Standard features

- 1800°C maximum operating temperature
- Programmable temperature controller with 24 segments.
  - HTRH fitted with Carbolite Gero EPC3016P1
  - HTRH-3 fitted with Carbolite Gero CC-T1
- Over-temperature protection
- Accepts work tubes with outer diameters up to 100 mm for use with modified atmosphere
- Accepts work tubes with outer diameters up to 200 mm for use in air
- Heated lengths of 100, 250, 300 or 600 mm
- High grade thermocouple type B
- Low thermal mass ceramic fibre insulation
- High quality  $\text{MoSi}_2$  heating elements in a vertical, hanging position
- Rectangular housing with holes for convection cooling
- Available with 1–3 heating zones
- Furnace comes with separate control box with 3 m cable, plug and socket
- **NEW** Ethernet communications

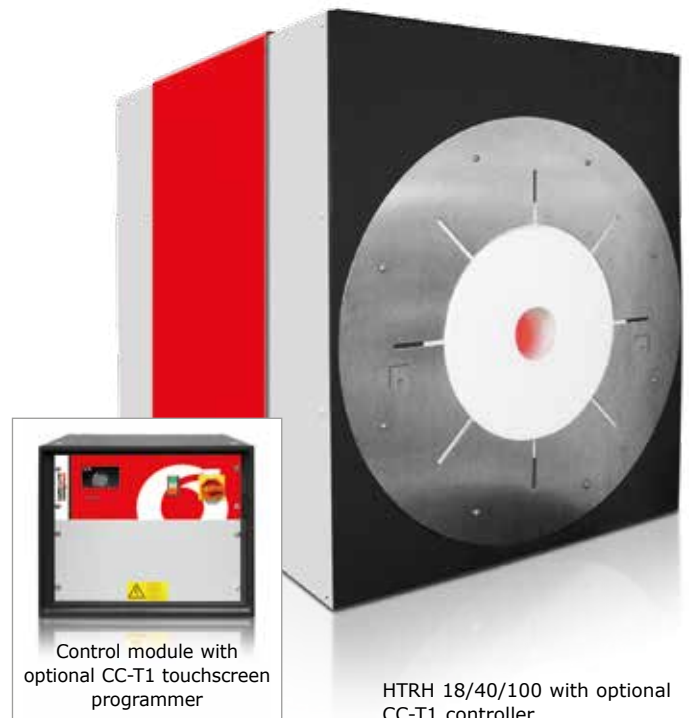

### Options (specify these at time of order)

- A range of sophisticated digital controllers, multisegment programmers and data loggers with digital communication options is available (see pages 36–40)
- A range of additional work tubes is available in a variety of materials (see page 41)
- Insulation plugs & radiation shields are strongly recommended for high temperature vertical tube furnaces to prevent heat loss & improve uniformity (see page 45)
- Modified atmosphere and vacuum assemblies are available (see page 45)
- Vacuum packages with a choice of rotary vane pump or turbomolecular pump are available (page 46)
- Oxygen sensor for inert gas packages
- Gas packages with manual or automatic valve for up to 3 gases (page 47)
- 6 m long cable between furnace body and control box with plug and socket

### View inside

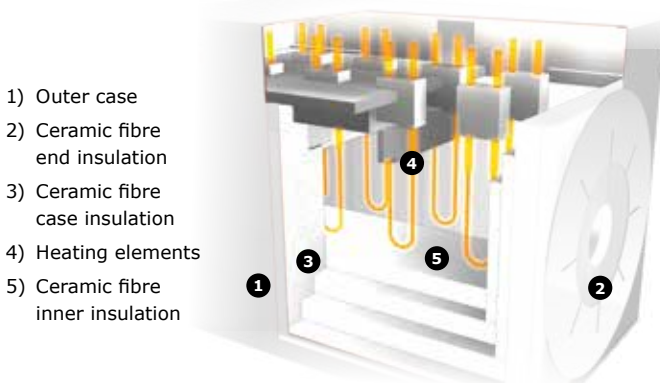

### HTRH-3 furnace with three heating zones

**Better temperature uniformity can be achieved by dividing the heated length into 3-zones.**

Each zone is equipped with a dedicated thermocouple and controller, which is especially useful to preheat gases required for reactions inside the system. The HTRH tube furnaces do not include an integral work tube. The work tube must be selected as an additional item. The work tube length is dependent on the application and will vary if used with or without modified atmosphere or vacuum.

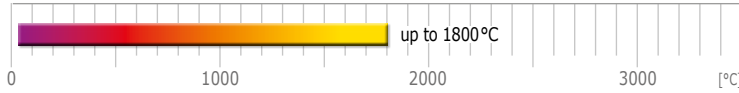

Horizontal High Temperature Tube Furnace HTRH 18/70/600 with optional EPC3008P10 programmer and optional high vacuum capable inert gas package (high vacuum capable up to 1450°C and up to 1800°C under normal pressure. Rotary vane pumps and turbo pumps optional available (see page 46).

## Technical data

Model	Max. temperature [°C]	Dimensions: Max. outer Ø accessory tube [mm]	Dimensions: Heated length [mm]	Recommended tube length		Dimensions: External H x W x D [mm]	Furnace weight [kg]	Dimensions: Control module H x W x D* [mm]	Control module weight [kg]	Uniform length ± 5°C [mm]	Max. power [W]
				for use in air [mm]	for use with modified atmosphere [mm]						

### Single Zone High Temperature Horizontal Tube Furnaces HTRH

HTRH __/40/100	1600	40	100	380	915	510 x 390 x 420	45	480 x 560 x 500	50	50	2200
HTRH __/40/250	1600, 1700, 1800	40	250	530	1065	510 x 540 x 420	45	480 x 560 x 500	50	125	3600
HTRH __/40/500	1600, 1700, 1800	40	500	780	1275	510 x 790 x 420	60	850 x 560 x 500	90	250	8000
HTRH __/70/150	1600, 1700	70	150	440	975	620 x 450 x 520	65	480 x 560 x 500	60	75	4500
HTRH __/70/300	1600, 1700, 1800	70	300	580	1115	620 x 590 x 520	65	850 x 560 x 500	60	150	6400
HTRH __/70/600	1600, 1700, 1800	70	600	880	1415	620 x 890 x 520	90	850 x 560 x 500	90	300	8000
HTRH __/100/150	1600	100	150	440	975	620 x 450 x 520	75	480 x 560 x 500	60	75	4800
HTRH __/100/300	1600, 1700, 1800	100	300	580	1115	620 x 590 x 520	90	850 x 560 x 500	90	150	7500
HTRH __/100/600	1600, 1700, 1800	100	600	880	1415	620 x 890 x 520	120	850 x 560 x 500	90	300	10900
HTRH __/150/600	1600, 1700, 1800	150	600	880	Not available	670 x 890 x 570	140	850 x 560 x 500	90		12000
HTRH __/200/600	1600, 1700, 1800	200	600	880	Not available	720 x 890 x 620	180	850 x 560 x 500	90		12000

### 3-Zone High Temperature Horizontal Tube Furnaces HTRH

HTRH-3 __/70/600	1600, 1700, 1800	70	600	880	1415	620 x 890 x 520	120	850 x 560 x 500	180	350	8000
HTRH-3 __/100/600	1600, 1700, 1800	100	600	880	1415	620 x 890 x 520	120	850 x 560 x 500	180	350	10900
HTRH-3 __/100/900	1600, 1700, 1800	100	900	1180	1715	680 x 1190 x 650	250	1100 x 1200 x 700	230		20000
HTRH-3 __/150/600	1600, 1700, 1800	150	600	880	Not available	670 x 890 x 570	180	850 x 560 x 500	180		12000
HTRH-3 __/150/900	1600, 1700, 1800	150	900	1180	Not available	680 x 1190 x 650	250	1100 x 1200 x 700	230		20000

**i** Please note:

- Heat up rate when using an optional ceramic work tube must be limited to 5°C/min
- The power supply is based on 200–240 V for 1 phase and 380–415 V for 3 phase power
- Minimum uniform length in horizontal furnace with insulation plugs fitted at 100°C below max. temperature

- Maximum continuous operating temperature is 100°C below maximum temperature
- \* Further to the depth of the control module 150 mm for the power plugs and other plugs needs to be added



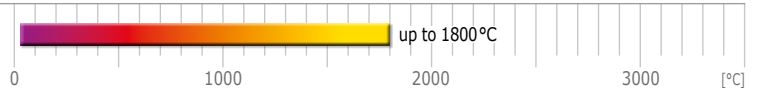

## HTRV – High Temperature Vertical Tube Furnaces

**The HTRV high temperature tube furnaces are designed for vertical orientation and operation up to 1800°C.**

The high grade insulation material consisting of fibre plates provide low energy consumption and high heating rates due to their low thermal conductivity. The insulation and the molybdenum disilicide (MoSi<sub>2</sub>) heating elements are installed in a rectangular housing. The heating elements hang vertically and can be easily replaced. At higher temperatures and in the presence of oxygen, MoSi<sub>2</sub> develops an oxide layer which protects the heating elements against further thermal or chemical corrosion.

With its wide range of accessories, the comprehensive HTRV range provides complete system solutions for ambitious thermal treatment at high temperatures.

Furnaces are supplied without a stand, allowing customers to build them into their own equipment. Optional 'L' stands are available allowing the furnaces to be self supporting.



HTRV 18/70/250 with optional CC-T1 controller, optional 'L' stand, optional voltage/current display and optional high vacuum/inert gas package (high vacuum possible up to 1450°C). Rotary vane and turbomolecular pumps available as options.

### Standard features

- 1800°C maximum operating temperature
- Carbolite Gero EPC3016P1 programmable temperature controller with 24 segments
- Over-temperature controller with independent thermocouple
- Optimized for vertical usage
- Accepts work tubes with outer diameters up to 100 mm for use with modified atmosphere
- Accepts work tubes with outer diameters up to 200 mm for use in air
- Heated lengths of 100, 250 or 500 mm
- High grade type B thermocouple
- Low thermal mass ceramic fibre insulation
- Vertically hanging high quality MoSi<sub>2</sub> elements
- Rectangular housing with holes for convection cooling
- Furnace comes with separate control box with 3 m cable, plug and socket
- **NEW** Ethernet communications



Interior view of HTRV 18/70/250 at high temperature

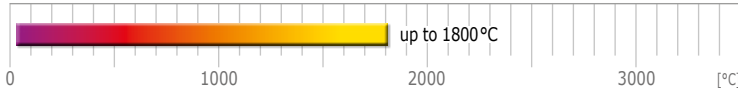

### Options (specify these at time of order)

- A range of sophisticated digital controllers, multisegment programmers and data loggers with digital communication options is available (see pages 36–40)
- A range of additional work tubes is available in a variety of materials (see page 41)
- Insulation plugs & radiation shields are strongly recommended for high temperature vertical tube furnaces to prevent heat loss & improve uniformity (see page 45)
- Modified atmosphere and vacuum packages are available (see page 45)
- Vacuum packages with a choice of rotary vane pump or turbomolecular pump are available (page 46)
- Stand for convenient and safe usage
- Oxygen sensor for inert gas packages
- Gas packages with manual or automatic valve for up to 3 gases (page 47)
- 6 m long cable between furnace body and control box with plug and socket



HTRV 17/150/250 with optional L-Stand, current / voltage display and recommended fibre insulation plugs

### Technical data

Model	Max. temperature [°C]	Dimensions: Max. outer Ø accessory tube [mm]	Dimensions: Heated length [mm]	Recommended tube length		Dimensions: External H x W x D [mm]	Furnace weight [kg]	Dimensions: Control module H x W x D* [mm]	Control module weight [kg]	Uniform length ± 5°C [mm]	Max. power [W]
				for use in air [mm]	for use with modified atmosphere [mm]						

#### High Temperature Vertical Tube Furnaces HTRV

HTRV __/40/100	1600, 1700	40	100	355	890	365 x 455 x 455	30	480 x 560 x 500	50	50	2000
HTRV __/40/250	1600, 1700, 1800	40	250	505	1040	515 x 455 x 455	40	480 x 560 x 500	50	125	3000
HTRV __/40/500	1600, 1700	40	500	755	1290	765 x 455 x 455	65	850 x 560 x 500	60	250	6000
HTRV __/70/100	1600, 1700	70	100	355	890	365 x 455 x 455	30	480 x 560 x 500	50	50	3000
HTRV __/70/250	1600, 1700, 1800	70	250	505	1040	515 x 455 x 455	40	850 x 560 x 500	60	125	4800
HTRV __/70/500	1600, 1700, 1800	70	500	755	1290	765 x 455 x 455	65	850 x 560 x 500	90	250	8000
HTRV __/100/250	1600, 1700, 1800	100	250	505	1040	515 x 455 x 455	45	850 x 560 x 500	60	125	7000
HTRV __/100/500	1600, 1700, 1800	100	500	755	1290	765 x 455 x 455	70	850 x 560 x 500	90	250	10400
HTRV __/150/250	1600, 1700, 1800	150	250	505	Not available	515 x 580 x 580	55	850 x 560 x 500	90		8000
HTRV __/150/500	1600, 1700, 1800	150	500	755	Not available	765 x 580 x 580	80	850 x 560 x 500	90		12000
HTRV __/200/250	1600, 1700, 1800	200	250	505	Not available	515 x 580 x 580	70	850 x 560 x 500	90		10000
HTRV __/200/500	1600, 1700, 1800	200	500	755	Not available	365 x 580 x 580	95	850 x 560 x 500	90		14000

**i Please note:**  
 - Heat up rate when using an optional ceramic work tube must be limited to 5°C/min  
 - The power supply is based on 200–240 V for 1 phase and 380–415 V for 3 phase power  
 - Minimum uniform length in horizontal furnace with insulation plugs fitted at 100°C below max. temperature  
 - Maximum continuous operating temperature is 100°C below maximum temperature

\* Further to the depth of the control module 150 mm for the power plugs and other plugs needs to be added

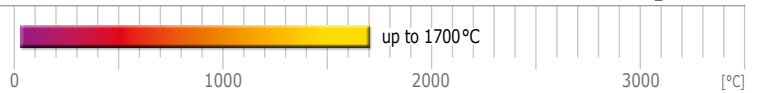

## HTRV-A – High Temperature Vertical Split Tube Furnaces

**The HTRV-A split tube furnaces have a maximum operating temperature of 1700 °C.**

The split heating module allows either easy positioning of the work tube or positioning around reactors which have fixed end flanges. The split design may also allow faster cooling of samples. The control thermocouple is fitted in the centre of the heating zone. Cooling channels are engineered into the housing to aid with convection cooling of the outer case. The two furnace chamber halves consist of high grade insulation plates with vertically hanging  $\text{MoSi}_2$  heating elements. A safety switch protects the operator by switching off the heating elements once the furnace is opened.

Furnaces are supplied without a stand, allowing customers to build them into their own equipment. Optional 'L' stands are available allowing the furnaces to be self supporting.

### Standard features

- 1600 and 1700 °C maximum operating temperatures
- Carbolite Gero EPC3016P1 programmable temperature controller with 24 segments
- Over-temperature controller with independent thermocouple
- Designed for vertical use
- Accepts work tubes with outer diameters up to 100 mm for use with modified atmosphere
- Heated lengths of 120, 250, 500 or 700 mm
- High grade type B thermocouple
- Low thermal mass ceramic fibre insulation
- Vertically hanging high quality  $\text{MoSi}_2$  heating elements
- Supplied with separate control box and 3 m cable, plug and socket
- **NEW** Ethernet communications



HTRV-A 17/100/700 with optional stand

### View inside the HTRV-A

- 1) Outer case
- 2) Ceramic fibre end insulation
- 3) Ceramic fibre case insulation
- 4) Heating elements
- 5) Ceramic fibre inner insulation

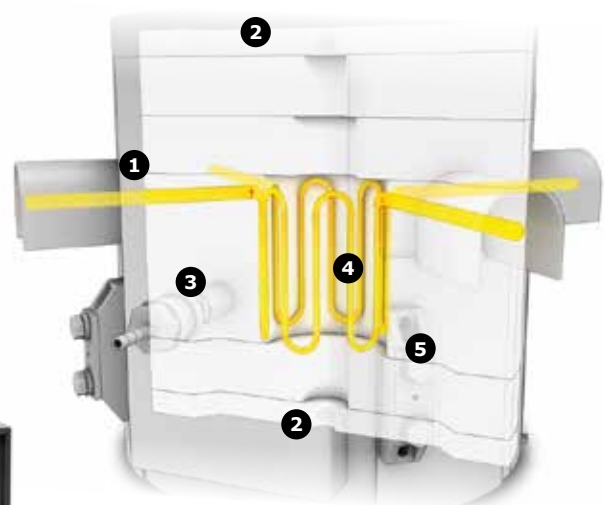

HTRV-A 17/70/250  
with optional basic inert gas bundle



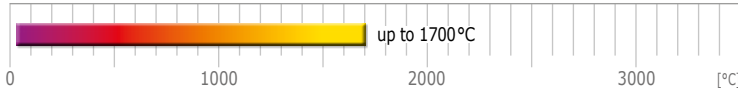

**Options** (specify these at time of order)

- A range of sophisticated digital controllers, multisegment programmers and data loggers with digital communication options is available (see pages 36 – 40)
- A range of additional work tubes is available in a variety of materials (see page 41)
- Insulation plugs & radiation shields are strongly recommended for high temperature vertical tube furnaces to prevent heat loss & improve uniformity (see page 45)
- Modified atmosphere and vacuum packages are available (see page 45)
- Vacuum packages with a choice of rotary vane pump or turbomolecular pump are available (page 46)
- Longer heated lengths
- Stand for convenient and safe usage
- Oxygen sensor for inert gas packages
- 6 m long cable between furnace body and control box with plug and socket
- Gas packages with manual or automatic valve for up to 3 gases (page 47)

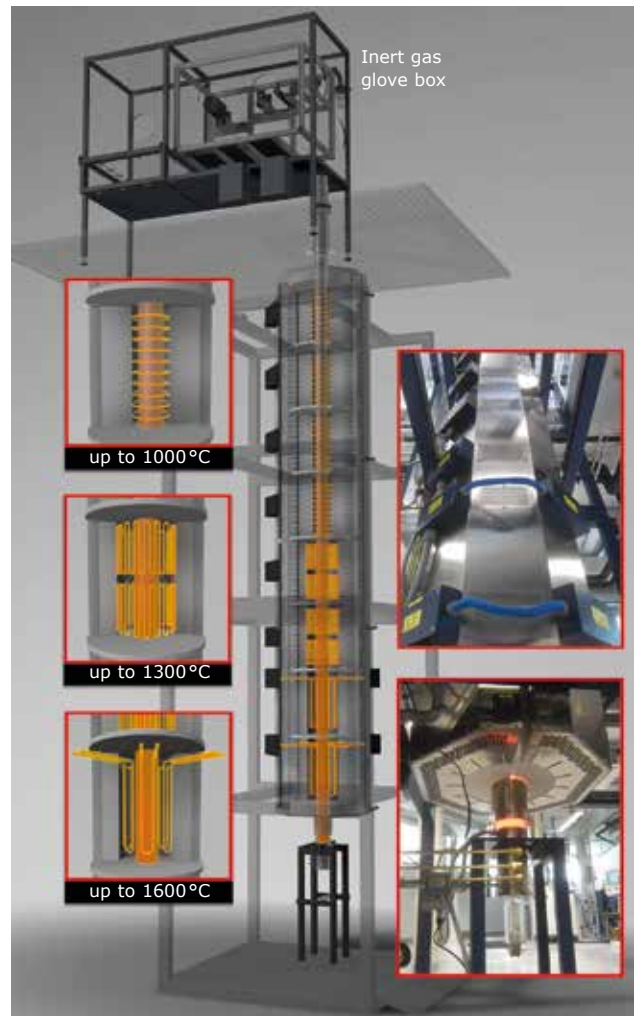

Custom designed 8-zone vertical split tube furnace, model HTRV-A 16/100/4000, with 4000 mm heated length. For debinding and sintering of fibres under inert gas atmosphere. The fibres are introduced into the furnace from an inert gas glove box.

**Technical data**

Model	Max. temperature [°C]	Dimensions: Max. outer Ø accessory tube [mm]	Dimensions: Heated length [mm]	Recommended tube length		Dimensions: External H x W x D [mm]	Furnace weight [kg]	Dimensions: Control module H x W x D* [mm]	Control module weight [kg]	Uniform length ± 5°C [mm]	Max. power [W]
				for use in air [mm]	for use with modified atmosphere [mm]						

High Temperature Vertical Split Tube Furnace HTRV-A

HTRV-A __/70/120	1600	70	120	470	910	700 x 700 x 890 (closed with stand)	65	850 x 560 x 500	60	50	4800
HTRV-A __/70/250	1600, 1700	70	250	600	1040	800 x 600 x 890 (closed with stand)	75	850 x 560 x 500	90	125	6000
HTRV-A __/70/500	1600, 1700	70	500	850	1290	1050 x 700 x 890 (closed with stand)	120	850 x 560 x 500	90	250	13000
HTRV-A __/70/700	1600, 1700	70	700	1050	1490	1250 x 800 x 990 (closed with stand)	170	850 x 560 x 500	120	350	19000
HTRV-A __/100/500	1600, 1700	100	500	850	1290	1050 x 800 x 990 (closed with stand)	140	850 x 560 x 500	120		13000
HTRV-A __/100/700	1600, 1700	100	700	1050	1490	1250 x 800 x 990 (closed with stand)	170	850 x 560 x 500	120		19000

**i Please note:**  
 - Heat up rate when using an optional ceramic work tube must be limited to 5°C/min  
 - The power supply is based on 200 – 240 V for 1 phase and 380 – 415 V for 3 phase power  
 - Minimum uniform length in horizontal furnace with insulation plugs fitted at 100°C below max. temperature

- Maximum continuous operating temperature is 100°C below maximum temperature  
 \* Further to the depth of the control module 150 mm for the power plugs and other plugs needs to be added



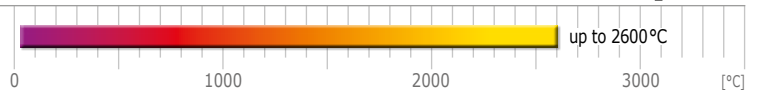

## HTRH-GR – Graphite Tube Furnace up to 2600 °C

**With the adjustable stand option, this range of Carbolite Gero graphite tube furnaces up to 2600 °C can be used at various angles, ranging from horizontal to vertical.**

Custom designed manually controlled horizontal graphite heating and insulated tube furnace up to 2200 °C, with integral compact frame including the gas and water supply, and separate temperature controller cabinet

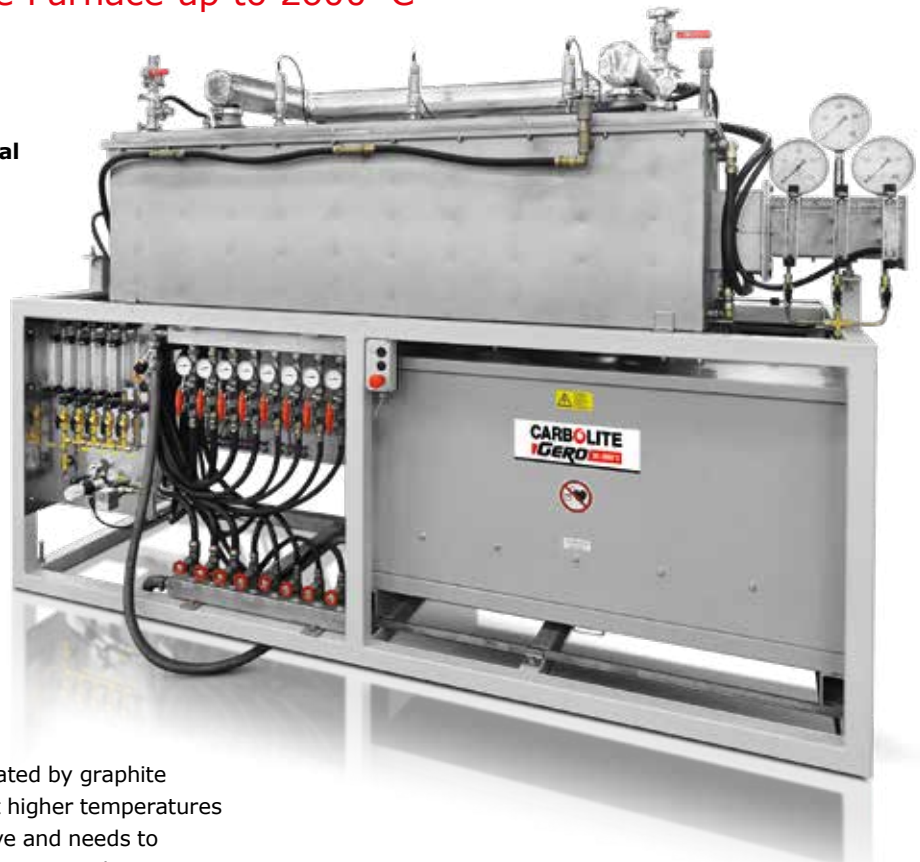

This range of cold wall tube furnaces is heated by graphite elements and insulated by graphite felt. At higher temperatures above 400 to 600 °C graphite is air sensitive and needs to be kept under either an inert gas or vacuum atmosphere. To maintain an oxygen free environment, the tube furnace is contained within in a water-cooled vacuum tight vessel sealed with rubber O-rings, which needs to be evacuated and purged with inert gas prior to heating.

The thermal conductivity of graphite felt insulation is very low making it an excellent material for furnace insulation. The thickness and quality of the insulation materials are specifically chosen depending on the maximum operating temperature of the furnace.

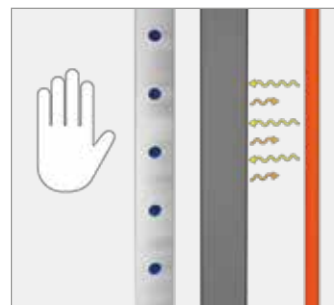

Insulation principle of the Graphite Tube Furnace; showing the graphite heater (red), the graphite felt insulation (dark grey) within the water cooled vessel

### Standard features

- 2200, 2400 or 2600 °C maximum operating temperature
- Graphite heating and insulation
- Heated length of 260 mm
- Semi-automatic control with Siemens KP 300 panel
- PID temperature programmer
- Pyrometer for temperature measurement
- Automatic gas valves with manual flowmeter for one inert gas
- Single stage rotary vane pump
- Water cooled vessel (cooling water provided by customer)
- Over-temperature protection
- Leakage rate (clean, cold, dry and empty) <math>< 5 \times 10^{-3}</math> mbar l/s
- Closed flanges during heat treatment mandatory

### Options (specify these at time of order)

- Full automated control by Siemens PLC S7-300
- Control panel TP1900 or WinCC for PLC
- Further inert gas controls (manual or automated)
- Double stage rotary and turbo pumps
- Adjustable angle stand
- Sliding thermocouple for accurate temperature control under 1500 °C
- Reference pyrometer (only with PLC)
- Water cooling chiller (if cooling water is not available)
- Special flanges with inert gas counter flow for open operation during heat treatment



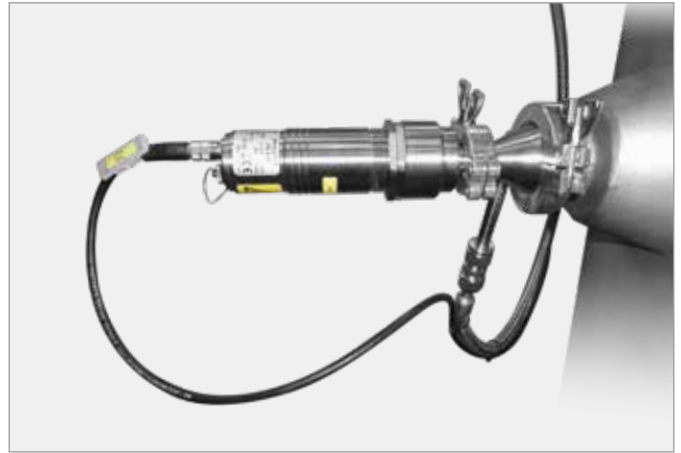
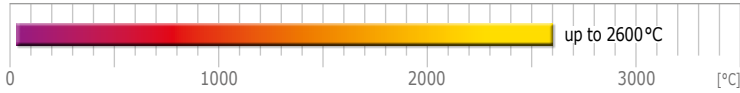

At temperatures higher than 1800°C, temperature measurement requires a pyrometer

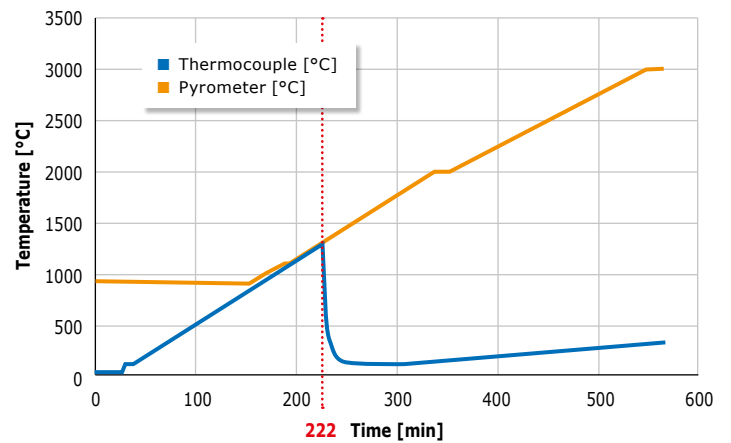
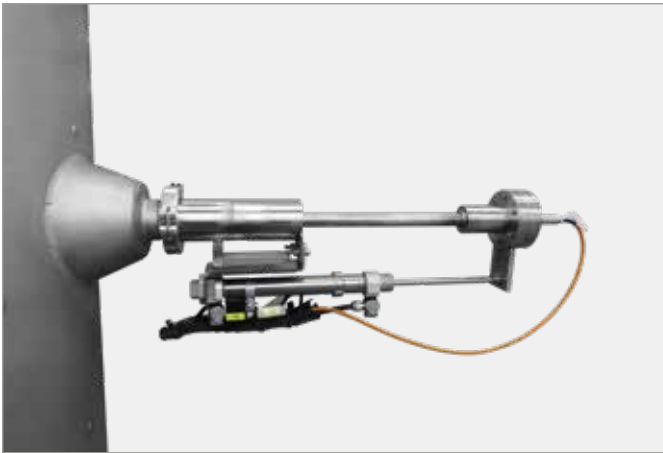

For accurate temperature measurement up to 1500°C an optional sliding thermocouple type S is recommended (left); example temperature measurement of pyrometer and sliding thermocouple (right). Here after 222 minutes the thermocouples slides out and the pyrometer takes over the temperature control.

## Technical data

Model	Max. temp. under Argon [°C]	Max. temp. under vacuum [°C]	Cooling time from 2000 °C [h]	Inner tube diameter [mm]	Heated length [mm]	Outer dimensions tube furnace without stand Ø* x W [mm]	Outer dimensions tube furnace with stand H x W x D [mm]	Outer dimensions control module H x W x D [mm]	Furnace weight in total [kg]	Required Argon gas flow [l/h]	Required cooling water flow [l/min]	Max. power [W]
<b>HTRH-GR 22/260</b>	2200	2200	5	50	260	400 x 900	1800 x 900 x 1000	1500 x 1500 x 1000	600	50-500	25	23000
<b>HTRH-GR 24/260</b>	2400	2200	5	50	260	400 x 900	1800 x 900 x 1000	1500 x 1500 x 1000	700	50-500	35	32000
<b>HTRH-GR 26/260</b>	2600	2200	5	50	260	400 x 900	1800 x 900 x 1000	1500 x 1500 x 1000	800	50-500	50	42000

**i Please note:**

- Heat up rate to 2000°C approx. 10°C/min, above 2000°C lower
- Power supply by 3 phase power with 380-415 Volts with neutral and earth required
- \*Further to the diameter of the tube furnace the current feed in connections have an outer diameter of 800 mm

- Inert gas and cooling water supply mandatory
- Maximum continuous operating temperature is 100°C below maximum temperature
- Above 2000°C the wear down of the heating elements grows with raising temperature exponentially



## Gradient Tube Furnaces

**The Carbolite Gero range of gradient tube furnaces are design to provide a temperature ramp along the length of a work tube.**

A gradient tube furnace is divided into a number of heating 'zones' along the length of the furnace. Each zone has its own individual temperature controller which can be set to independent temperatures, achieving a pre-determined temperature profile along the work tube.

Some heat will naturally transfer between adjacent heating zones and therefore zone barriers are employed in the TG models to minimize this effect. The AZ models are not equipped with heat barriers. Examples of heating profiles are shown on each product page.

Chemical vapour transport (CVT) and physical vapour transport (PVT) reactions

### Chemical vapour transport (CVT) and physical vapour transport (PVT) reactions

- The gradient furnace can be used to heat a reactor tube to provide the two distinct temperatures required in chemical vapour transport reactions
- Materials are vaporized in the hotter zone and condense in the cooler zone
- Extended tube furnace packages options are available to provide a sealed environment for this process
- Vacuum pump packages are also available if vacuum pressure is required
- High quality single crystals can be grown using this equipment.

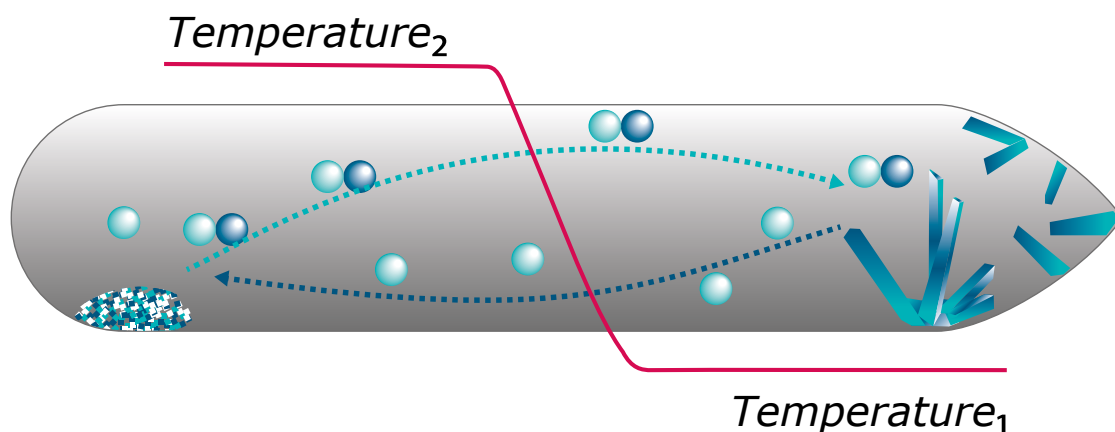

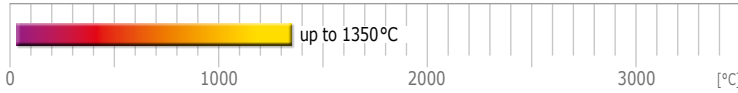

## AZ – 8-Zone Tube Furnaces

The AZ is an eight zone tube furnace for controlled temperature profiles. These zones can be used to generate temperature profiles along the heated length of the furnace.

With eight zones, thick insulation, and highly symmetrical winding of the heating elements throughout the entire AZ furnace, a uniformity of better than  $\pm 5^\circ\text{C}$  is achieved. A key advantage of the eight individually controlled zones is the extension of the uniform length inside the furnace. Additionally, the temperature profile can be precisely controlled for linear increases, peaks, or other user defined profiles. One process well suited for the AZ tube furnace is chemical vapour deposition as a temperature gradient can be established in the furnace for evaporation of precursor material at the high temperature end zone and



AZ 13/110/1000: This picture shows the high vacuum equipment and touch panel controller option

### Standard features

- Similar construction to FHA / FHC tube furnaces on pages 16–17
- Eight-zone control for variable heating profiles
- Gradients, linear increase/decrease etc. of temperature along the heated length
- Extended uniform temperature distribution
- Short heating and cooling rates
- Automatic operation
- Data recording for quality management
- Retransmission of setpoint
- Over-temperature controller with independent thermocouple

sublimation of the vapour on to the substrate at the cooler temperature end zone. All zones are individually controlled and monitored with thermocouples.

### Options (specify these at time of order)

- A range of sophisticated digital controllers, multisegment programmers and data loggers with digital communication options is available (see pages 36–40)
- Wide choice of tube diameters and materials is available. See pages 41 for tube materials
- 'L' stand for vertical usage
- Insulation plugs & radiation shields to prevent heat loss & improve uniformity (see page 45)
- Modified atmosphere and vacuum assemblies are available (see page 45)
- Vacuum packages with a choice of rotary vane pump or turbomolecular pump are available (page 46)
- Complete automation by Siemens SPS control with touch panel and mass flow controller for the gases on request
- Other diameters and heated lengths on request

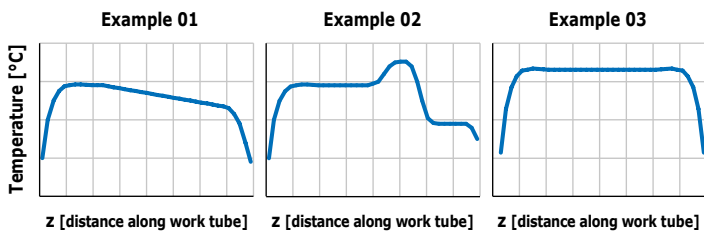

Three typical possible temperature profiles inside the furnace. The eight zones give maximum flexibility.

## Technical data

Model	Max. temp. [°C]	Dimensions: Max. Diameter accessory tube [mm]	Dimensions: Heated length [mm]	Dimensions: External H x W x D* [mm]	Transport weight** [kg]	Voltage [V]
<b>AZ 13/32/360</b>	1350	32	360	990 x 1800 x 500	500	400 (3P)
<b>AZ 13/50/430</b>	1350	50	430	990 x 1800 x 500	550	400 (3P)
<b>AZ 13/80/810</b>	1350	80	810	990 x 1800 x 500	600	400 (3P)
<b>AZ 13/110/1000</b>	1350	110	1000	1200 x 1800 x 520	650	400 (3P)

**i** Please note:  
- Maximum continuous operating temperature is 100°C below maximum temperature

\*Small models are supplied with a separate control box  
\*\*Max. weight including a high vacuum pumping station

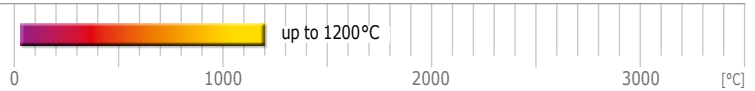

## Compact Gradient Split Tube Furnaces

**These compact split tube furnaces are specifically design to provide a temperature gradient along the length of the heated zones. They use free radiating wire elements embedded within the insulation of the furnace body. The benefit of this design is its flexibility; with the use of tube adapters the same furnace can be used with a variety of tube diameters.**

The TG2 furnace has two independent zones and TG3 has three independent zones. They are split tube furnaces that comprise a furnace body which is hinged and split into two halves along its length. This makes exchange of work tubes easier and also enables the furnace to be used with reactors or work tubes where end flanges would make insertion into a non-split furnace difficult. The TG2 furnace includes a 25 mm long unheated zone barrier between the two heated zones and the TG3 has two 75 mm long unheated zone barriers between the three heated zones. Each heated zone has its own temperature controller and thermocouple. This range of tube furnaces does not include an integral work tube which must be selected as an additional item. Should vacuum or a modified atmosphere be required, it is necessary to use a separate slide-in work tube of adequate length needed to fit end seals. This information can be found on pages 42–43. The use of a separate work tube has the advantage of protecting the heating elements from damage or contamination.

Note: The temperature gradient achievable is influenced by work tube diameter. Larger gradients will be achieved with smaller diameter work tubes because heat transfer between zones will be less.



TG2 12/125/425



TG3 12/60/600

### Standard features

- 1200°C maximum operating temperature
- Each zone has a Carbolite Gero EPC3016P1 programmable temperature controller with 24 segments
- TG3 12/60/600. Overall heated length of 600 mm divided into three 150 mm heated zones with two 75 mm unheated zone barriers
- TG2 12/125/425. Overall heated length of 425 mm divided into two 200 mm heated zones with a 25 mm unheated zone barrier
- Wire elements in high quality vacuum formed insulation ensure fast heat up, excellent temperature control and short cool down times
- Furnace splits into two halves and accommodates tubes or samples fixed into a test rig
- Furnace body detachable from the control box to allow use of optional mounting arrangements (see pages 6–7)
- Control module with 2 metre cable to furnace with plug and socket

### Options (specify these at time of order)

- Over-temperature protection for each heated zone (recommended to protect valuable contents & for unattended operation)
- A range of additional work tubes (page 41), end seals (page 44) and work tube packages (pages 42–43) is available for use with modified atmosphere and/or vacuum
- Vacuum packages with a choice of rotary vane pump or turbomolecular pump are available (page 46)
- Wide choice of tube diameters and materials is available.
- See page 41 for tube materials
- Insulation plugs and radiation shields to prevent heat loss
- Vertical mounting stand for the furnace body including bracket for mounting the furnace body to customer's equipment
- 4 m long extension cable to give a total 6 m length of cable between furnace body and control box
- Gas packages with manual valve (page 47)
- Gas packages with electrically operated valve for up to 2 gases (page 47)

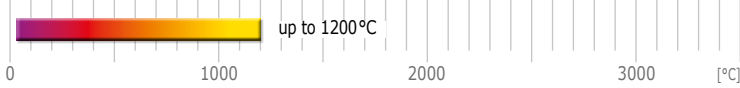

## Heat treatment

A sample could be moved between two temperature zones to achieve a desired heat cycle without waiting for a single zone furnace to heat or cool.

**Temperature Gradient, Horizontal TG2 12/125/425.**  
80 mm OD worktube.  
Setpoints: **zone 1: off, zone 2: 1100°C**

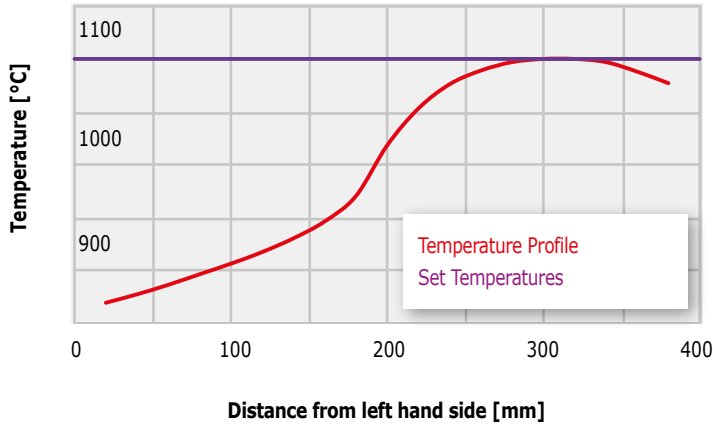

**Temperature Gradient, Horizontal TG2 12/125/425.**  
80 mm OD worktube.  
Setpoints: **zone 1: 1000°C, zone 2: 1100°C**

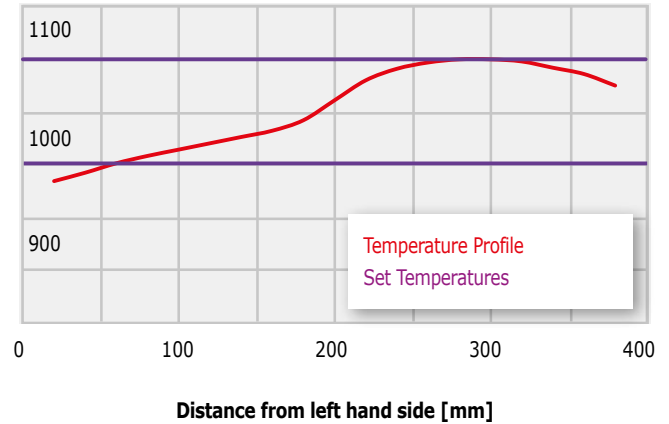

**Temperature Gradient, Horizontal TG3 12/60/600.**  
60 mm OD worktube.  
Setpoints: **zone 1: 1100°C, zone 2: 950°C, zone 3: 800°C**

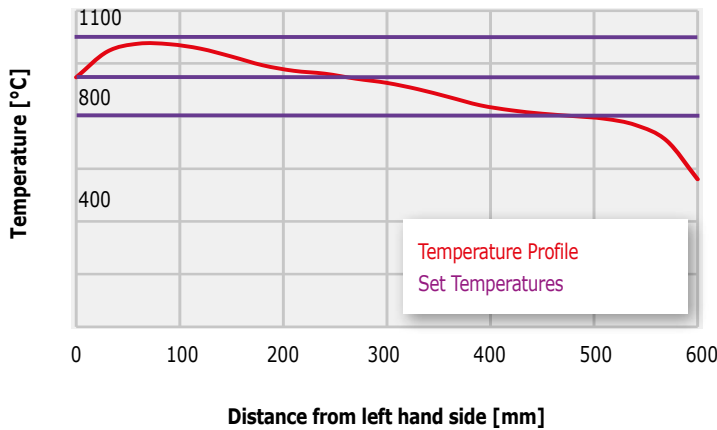

**Temperature Gradient, Horizontal TG3 12/60/600.**  
60 mm OD worktube.  
Setpoints: **zone 1: 1100°C, zone 2: off, zone 3: 400°C**

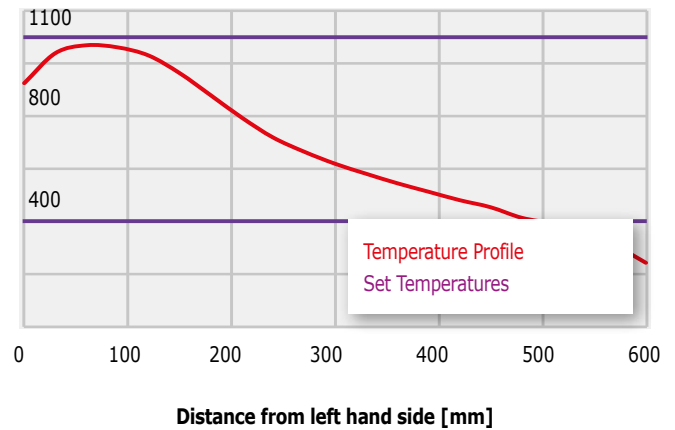

## Technical data

Model	Max. temp. [°C]	Heat-up time [mins]	Dimensions: Max. outer Ø accessory tube [mm]	Dimensions: Overall heated length [mm]	Recommended tube length		Dimensions: External Furnace H x W x D [mm]	Dimensions: Control module H x W x D [mm]	Max. power [W]	Thermo-couple type	Weight [kg]
					for use in air [mm]	for use with modified atmosphere [mm]					
TG3 12/60/600	1200	-	60	600	880	1050	560 x 795 x 480	220 x 785 x 480	2000	N	56
TG2 12/125/425	1200	134	125	425	750	1000	645 x 665 x 575	220 x 655 x 480	1860	N	71

**i Please note:**

- Heat up time is measured to 100°C below max, using an empty quartz tube & insulation plugs
- Heat up rate when using an optional ceramic work tube must be limited to 5°C/min
- Holding power is measured at continuous operating temperature

- Temperature gradients are measured with insulation plugs fitted
- Maximum continuous operating temperature is 100°C below maximum temperature



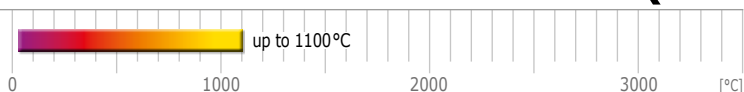

## HTR – Rotary Reactor Tube Furnaces

The HTR furnaces combine in a laboratory scale unit many of the advantages of a fluidised bed reactor with those of a rotary kiln.

The sample is simultaneously heated and mixed under a controlled atmosphere. This overcomes the longer reaction times required in standard chamber or tube furnaces.



HTR 11/150

### Standard features

- 1100°C maximum operating temperature
- Carbolite Gero EPC3016P1 programmable temperature controller with 24 segments
- Heating is provided by long life, rapid heating, resistance wire elements mounted in rigid, half cylindrical vacuum formed insulation modules
- Quartz reaction vessel included as standard
- The fluted internal surface of the quartz reactor ensures thorough mixing as the variable speed electric drive system oscillates the reactor tube through 315°
- A positive break safety interlock switch cuts power to the elements when the heating chamber is open
- Gas enters the reactor through a flexible silicon rubber tube
- A 30 mm flow meter for nitrogen is provided
- A single seal gasket directs the reactor exhaust into a removable stainless steel exhaust box from where a gas outlet allows piping to an extraction system

### Options (specify these at time of order)

- A range of sophisticated digital controllers, multisegment programmers and data loggers with digital communication options is available (see pages 36–40)
- Over-temperature protection (recommended to protect valuable contents & for unattended operation)
- Single or multiple flow meters for different gases
- Optional inconel reactor

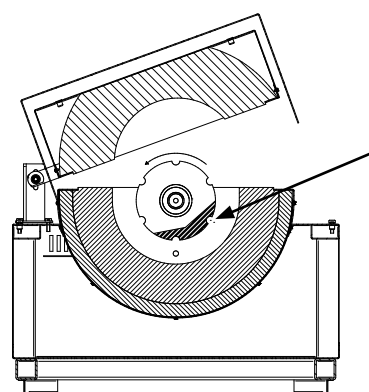

Internal flutes in the vessel lift the powder to increase its exposure to the atmosphere gas

## Technical data

Model	Max. temp. [°C]	Heat-up time [mins]	Max. continuous operating temp. [°C]	Cooling time with lid open [mins]	Dimensions: Reaction chamber dimensions [mm]	Dimensions: Reaction chamber capacity [ml]	Dimensions: Oscillation frequency per min	Dimensions: Rotation in each direction	Dimensions: External H x W x D [mm] lid down	Dimensions: External H x W x D [mm] lid open	Max. power [W]	Holding power [W]	Thermocouple type	Weight [kg]
HTR 11/75	1100	11	1000	15	75 x 100	50	1 to 8	315°	480 x 1140 x 550	800 x 1140 x 680	1500	400	K	40
HTR 11/150	1100	21	1000	15	150 x 200	700	1 to 8	315°	540 x 1300 x 900	950 x 1300 x 900	3000	1000	K	95

**i** Please note:  
- Holding power is measured at continuous operating temperature

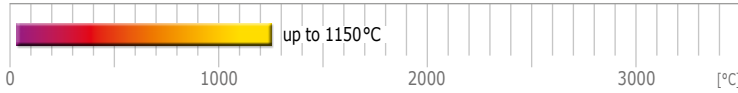

## RHST & RHZS – Rotating Horizontal Split Tube Furnaces

The range of Carbolite Gero horizontal rotating tube furnaces offers the benefits of simultaneous heating and mixing of the sample, in addition to the use of an inert atmosphere.

The furnaces are suitable for continuous material processing. Residence time in the heated zone depends on the degree of inclination and the rotating speed (which can be controlled by the customer) and the length of the working tube, in addition to the flow properties of the material.

The design of the split furnace, drive system and feeder/ collection assemblies allows the work tube to be easily removed and replaced.



RHZS 11/75/900 with optional inert gas package

### Standard features

- 1150 °C maximum operating temperature; normal operating temperature range 650 °C - 1050 °C
- Heated lengths of 600 mm and 900 mm
- Single zone models fitted with Carbolite Gero EPC3016P1 programmable temperature controller with 24 segments
- 3-zone models fitted with Carbolite Gero CC-T1 programmable temperature controller with 24 segments.
- Accepts work tube with outer diameter of 86 mm
- Adjustable inclination and rotation speeds offers flexibility of residence time
- Work tube rotation speed 1.5 to 10.0 revolutions per minute
- 5 litre capacity vibratory feeder and hopper
- The temperature controllers and associated equipment are housed within the integral control box
- Wire elements in high quality vacuum formed insulation ensure fast heat up, excellent temperature uniformity and short cool down times

The single zone and 3-zone split tube furnaces have a maximum operating temperature of 1150 °C. All models are available with heated lengths of either 600 mm or 900 mm. The angle of inclination can be easily adjusted between horizontal and 10°. The quartz work tube has an inner diameter of 81.6 mm. A safety switch automatically prevents heating and tube rotation when the furnace is opened.

It is essential to discuss your application with Carbolite Gero to ensure the suitability of the material for use in this equipment. Carbolite Gero cannot accept responsibility for your process due to the possibility of the material becoming sticky when heated and therefore not flow through the work tube.

### Options (specify these at time of order)

- Metallic (up to 800 °C) work tubes
- Inert gas packages available on request

## Technical data

Model	Max. temperature [°C]	Dimensions: Max. outer Ø accessory tube [mm]	Dimensions: Heated length [mm]	Work tube length [mm]	Dimensions: External H x W x D [mm]	Max. power [W]
<b>Single Zone Rotating Horizontal Split Tube Furnace RHST</b>						
<b>RHST 11/75/600</b>	1150	86	600	1500	1500 x 2200 x 550	3800
<b>RHST 11/75/900</b>	1150	86	900	1500	1500 x 2200 x 550	5500
<b>3-Zone Rotating Horizontal Split Tube Furnace RHZS</b>						
<b>RHZS 11/75/600</b>	1150	86	600	1500	1500 x 2200 x 550	3800
<b>RHZS 11/75/900</b>	1150	86	900	1500	1500 x 2200 x 550	5500

**i** Please note:  
- Maximum continuous operating temperature is 100°C below maximum temperature

The range of high quality PID (Proportional, Integral, Derivative) temperature controllers shown below are fitted to Carbolite Gero products. These controllers provide accurate temperature control that closely follows programmed ramp rates and setpoint temperatures. The full range is not fitted to all products, please see product pages for details.

## NEW Touch screen controller

### CC-T1 touch screen controller

**The CC-T1 touch screen controllers offer programmable control in which 24 segments may be set as ramp, step or dwell and may also be configured to control relays.**

The CC-T1 series provides a touch screen interface giving intuitive access to a comprehensive menu including: selection and editing of program profiles; scheduling of programs at a defined date/time; data logging of setpoint and actual temperature; localization of language; user level security. The CC-T1 series can also store and retrieve 10 unique program profiles. Data-logging is to a csv file which is accessed through the adjacent USB port. Ethernet communication is fitted as a standard feature.

When specified with a 3-zone product the control method is user selectable to be either retransmission of setpoint or independent control. With retransmission of setpoint the main zone controller's setpoint is automatically applied to the other zones. When running a program all zones will follow the program profile. With independent control each zones setpoint is set manually.

#### Standard features

- 4.3" colour touch screen
- Setpoint control
- Program profile control
- 10 unique program profiles saved in memory
- 24 segments per unique program
- Ethernet communication
- Panel mounted USB socket
- Data logging to a USB memory stick in a .csv file format
- Real time clock
- Program schedule start
- Program status indication with estimate end time & date
- Event indication (2 events)
- Control power indication
- User level security
- Dual temperature calibration
- Language setting: English, German, French, Italian, Spanish, Chinese, Russian, Japanese
- 3-zone version: retransmission of setpoint



The new CC-T1 touch screen controller in use.

#### Options (specify these at time of order)

- Over-temperature protection (independent controller)
- Alarm activation of relays to operate devices such as a door interlock
- Program segment events
- Temperature alarm relay connections
- Cascade control
- Ethernet to USB adapter. To connect one product direct to a computer
- Ethernet firewall router with DHCP capability. To connect one product to an Ethernet network

#### User level functionality

User level	Functions
<b>Operator</b>	Change temperature setpoint • Run pre-configured programs • Run data logging
<b>Supervisor</b>	All of the above plus: • Configure and edit programs • Manage alarms
<b>Administrator</b>	All of the above plus: • Set language, time and date • Edit data logging settings • Edit settings including calibration and serial communication

### Navigation screen

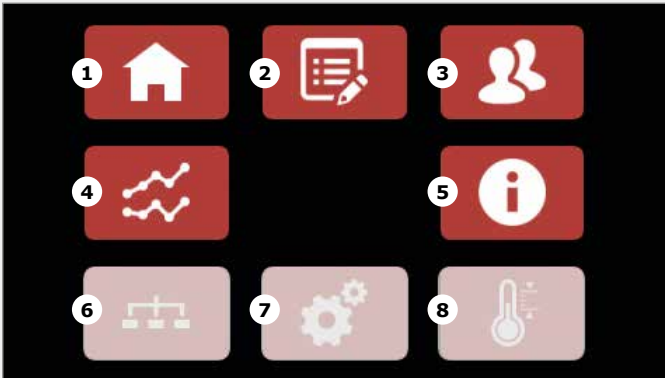

The navigation screen gives easy access to all the CC-T1 functions.

- 1) Home
- 2) Program view
- 3) User login
- 4) Data logging
- 5) Information
- 6) Communication settings
- 7) Settings
- 8) Offset calibration

### Home screen single zone

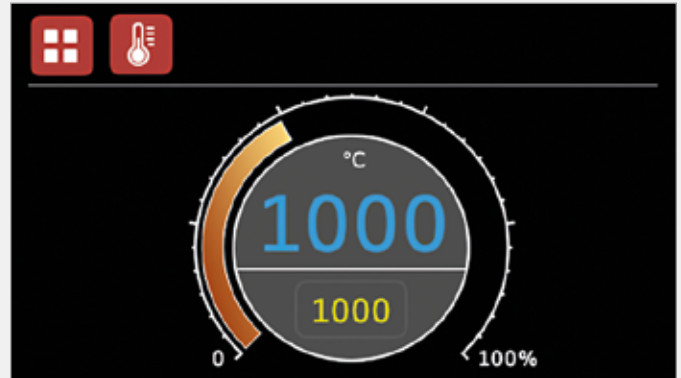

The home screen shows the setpoint, actual temperature and the heating power.

### Home screen program running

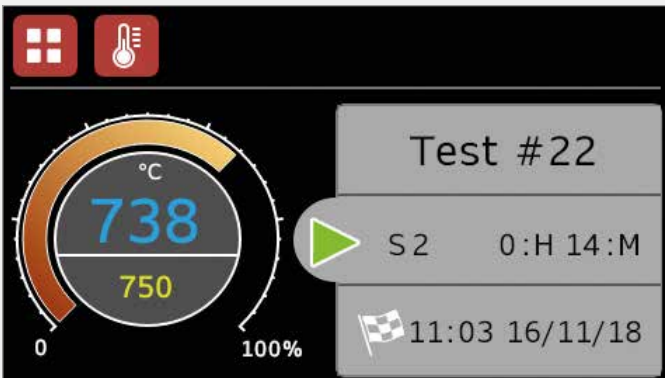

When a program is running the home screen shows a summary of the progress of the program. This includes: the program name; the current program segment and the time remaining in that segment; the end time and date of the program

### Home screen 3-zone

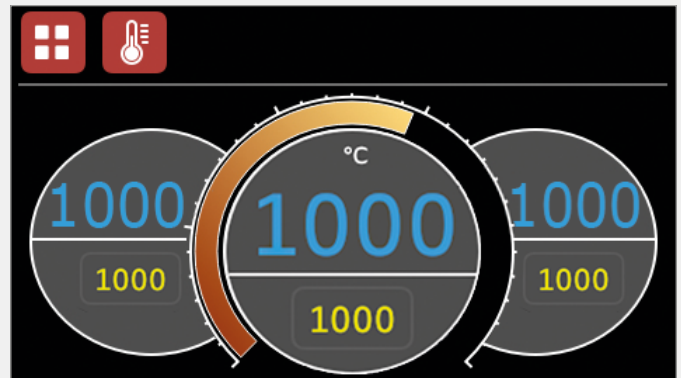

For a 3-zone product the home screen shows the setpoint and actual temperature of each zone. The user can select the end zones to either follow the centre zone temperature or run independently.

### Program view screen

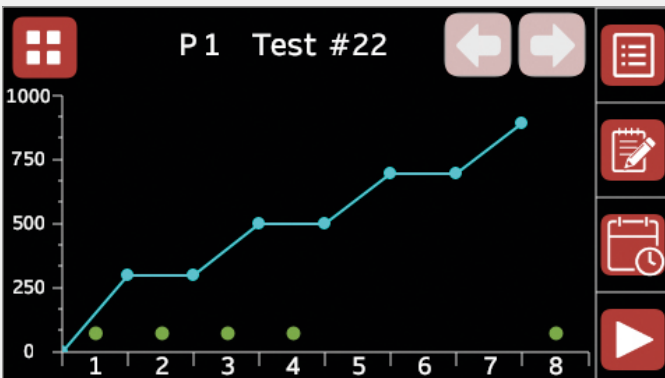

The program view screen shows a graphical summary of the selected program. It also give access to: Program selection; program creation and editing; scheduling a program to run at a specific time and date and running a program.

### Data Logging Screen

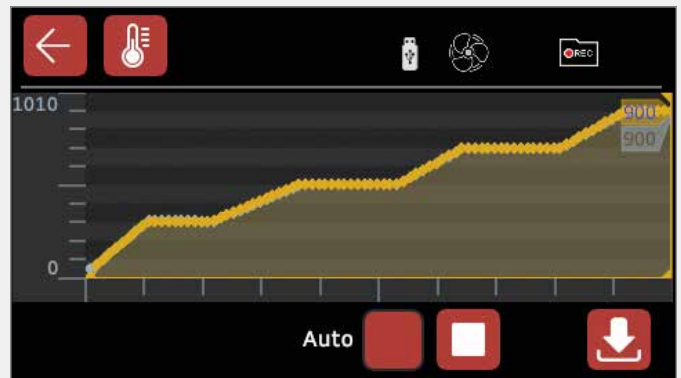

The data logging screen shows a graphical view of the setpoint and actual temperature along with the status of any configured relays. Data is logged to a USB stick in a .csv file format. Data logging can be started manually or automatically when a program is run.

## New EPC3016 & EPC 3008

### EPC3016P1

Programmable temperature controller

- 1 program with 24 segments
- Ramp, dwell, step, call, end segments
- 2 x relay
- Ethernet communication fitted
- certified for cybersecurity communications robustness

This controller offers programmable control in which 24 segments may be set as ramp, step or dwell and may also be configured to control relays. Ethernet communication is fitted as standard. If precise temperature control is required over a wide range of temperatures, the EPC3016P1 allows the use of multiple PID terms (gain scheduling). This feature is not enabled as standard, but can be activated on request.



### EPC3008P10

Programmable temperature controller

- 10 program with 24 segments
- Ramp, dwell, step, call, end segments
- 3 x relays
- Ethernet communication fitted
- certified for cybersecurity communications robustness

This controller offers programmable control in which 24 segments may be set as ramp, step or dwell and may also be configured to control relays. Ethernet communication is fitted as standard. The EPC3008P10 provides a comprehensive information display. If precise temperature control is required over a wide range of temperatures, the EPC3008P10 allows the use of multiple PID terms (gain scheduling). This feature is not enabled as standard, but can be activated on request. The EPC3008P10 can also store and retrieve 10 programs.



## Temperature controller features and options

Temperature controller model	EPC3016P1	EPC3008P10	CC-T1	nanodac
------------------------------	-----------	------------	-------	---------

### Furnace control

Number of programs	1	10	10	100
Number of segments per program	24	24	24	25
Relay operated options (e.g. solenoid valve, cooling fan, door lock, etc.) maximum	2	3	2	3
Cascade control	No	Optional	Optional	Optional
Auto tune	Yes	Yes	Yes	Yes

### User interface

Screen Resolution	4 digits + 16 segment scrolling text	4.5 digits + 5 character 16 segment text + 16 segment scrolling text	TFT colour LCD 480 x 272 pixels	TFT colour LCD 320 x 240 pixels
Screen size (inch)	1.6"	2.5"	4.3"	3.5"
Interface	4 buttons	4 buttons	Touchscreen	4 buttons
Start time configurable (e.g. to use night power rates)	No	No	Yes	Optional
Real-time clock with calendar	No	No	Yes	Yes
Data logging of process data with USB-flash drive	No	No	Yes	Yes
Data logging to secure file	No	No	No	Yes
Programming and data logging software	Optional	Optional	Optional	Optional
User levels	Yes	Yes	Yes	Yes
Program names displayed	Program number	Program number	Individual program name	Individual program name
Choice of languages	5	5	8	5

### Communications

Ethernet communication connection	Yes	Yes	Yes	Yes
Certified for cybersecurity communication robustness	Yes	Yes	Yes	Yes
USB connection (for data export)	No	No	Yes	Yes



## Eurotherm nanodac™

### Recorder & PID controller

In this configuration the nanodac™ combines precision PID temperature control, with a fully functional data logger. The full colour display can be changed to display text in English, French, German, Italian or Spanish.

Data is continuously logged into either CSV (comma separated variable) or securely to UHH (Eurotherm Hydra History) files. Data can be archived onto a USB flash drive or via Ethernet to a networked server. Up to 4 channels can be recorded, with up to 14 virtual channels that can be set to record trends, alarms, communications or mathematical functions such as totals or averages.

Logged files can be opened and displayed on a PC, in chart form, using Eurotherm Review Lite software.



In this configuration the nanodac™ can hold up to 100 programs

### Recorder & PID programmable controller

In addition to the above this controller offers programmable control in which 25 segments may be set as a ramp, step or dwell and may also be configured to control relay outputs. It stores and retrieves 100 programs.

Additional programs can be saved to, and retrieved from, a networker server via a USB flash drive or Ethernet. The action of up to 3 relays can be linked to a program segment; this can be used to switch on external devices such as gas solenoid valves and audible alarms Note that some configurations may require additional components.

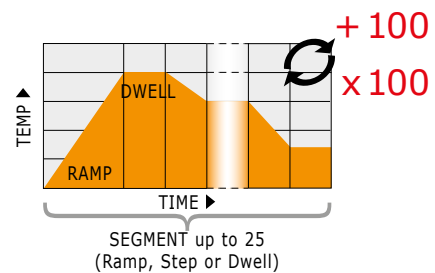

### **NEW** Batch recording option

Batch records form a part of recording history and are identified by messages that are written to the history file indicating when a batch starts and ends, along with additional customisable textual information.

Batches can be initiated directly by the operator, automatically whenever a specific PV value is reached, or remotely via Modbus.

### Over-temperature control option

This has a variable set point to protect either the furnace, oven or the load. If the main controller is a EPC3016P1, EPC3008P10 or nanodac™ this is provided by the addition of an independent controller. Whilst all Carbolite Gero products are designed to fail safe in the event of a controller malfunction, overtemperature protection is strongly recommended for unattended operation or where valuable loads are to be processed.



## Ethernet Communication

- Ethernet communication fitted as standard where the controller is CC-T1, EPC3016P1, EPC3008P10 and nanodac
- Requires, but does not include, suitable PC based software (eg iTools) and connection cables
- Ethernet to USB converters are available
- Ethernet firewall router with DHCP capability. To connect one product to an Ethernet network

## Cascade control

This feature offers the benefit of precise temperature control of the load. A standard controller operates by sensing the temperature close to the elements. With cascade control the controller's operation includes a second control thermocouple, which is used to sense the temperature of the load. It is essential that the controller is a CC-T1, dual loop EPC3008P10 or dual loop nanodac™.

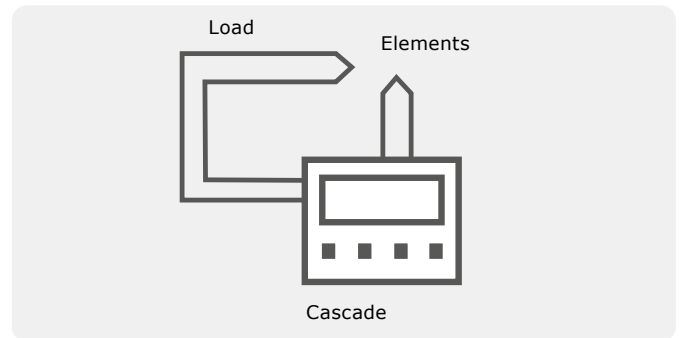

## Three zone control

This has the function in 3-zone tube furnaces of extending the length of the uniform heated zone.

### Retransmission of set point

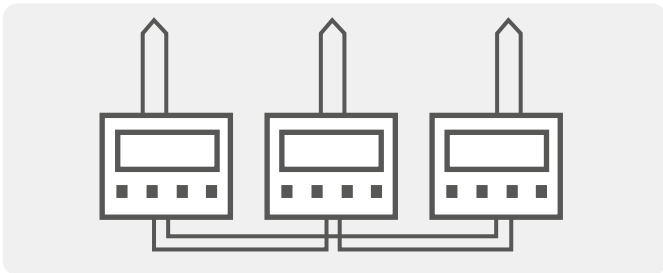

This is the standard method of control for all Carbolite Gero 3-zone furnaces. When the operator adjusts the setpoint of the centre zone controller, the setpoint of both end zones are automatically set to the same value. When a program is run in the centre zone all zones will automatically follow the program. Each controller has one thermocouple positioned with the tip close to the centre of each zone.

### Independent control

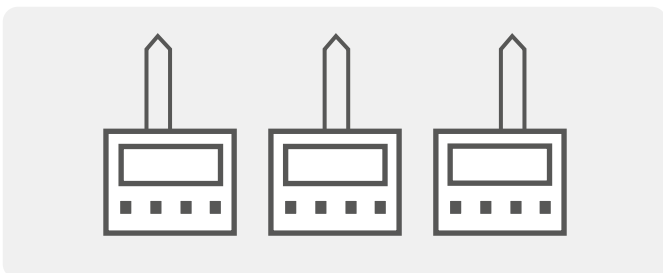

This configuration comprises independent controllers, each with an independent thermocouple in its respective zone. This is the standard method for the TG gradient tube furnaces.

### Three zone cascade control

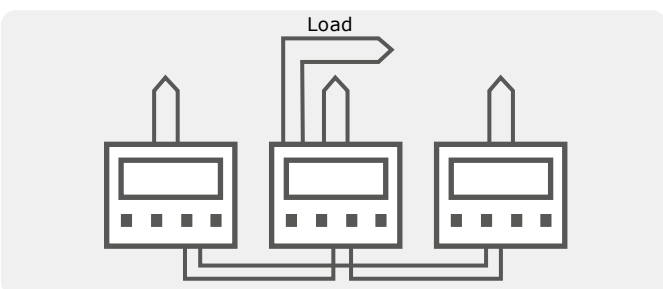

As in single zone furnaces, cascade control allows faster heating of the furnace load and more precise control of the load temperature. A CC-T1, EPC3008P10 or nanodac™ controller is required.

## Work Tube Selection Guide

The material, length and diameter of the work tube required for use with each furnace differs. The appropriate material work tube for each furnace can be selected from the tables below. Work tube length depends on whether the furnace will be used to work in air or with modified atmosphere/vacuum.

Tube material	Physical & chemical properties			Maximum temperatures [°C]		
				in air		under vacuum pressure
	Porous / Impervious	Resistance to thermal shock is partly dependent upon specific tube dimensions	Chemical resistance	Horizontal	Vertical	Horizontal and Vertical
<b>Sillimanite</b> (Al <sub>2</sub> SiO <sub>5</sub> )	Porous	Good	Good chemical resistance but porous	1500	1600	-
<b>Mullite C610 / IAP</b> (Impervious aluminous porcelain) (3Al <sub>2</sub> O <sub>3</sub> 2SiO <sub>2</sub> )	Impervious	Very good	Good chemical resistance against gases, with the exception of fluorine. Resistant to flux sulphurous or carbonaceous atmospheres	1450	1550	1350
<b>RCA C799</b> (Recrystallised alumina)	Impervious	Good	Highly resistant to chemical attack, with the exception of fluorine	1800	1900	1500 (Ø 75 mm)
						1450 (Ø > 75 to 88 mm)
<b>Quartz</b>	Impervious	Excellent	Generally good but reactive with sodium & at upper temperature limit with metals, carbonates & halides	1150	1200	1150
<b>APM (Advanced powder metallurgy - FeCrAl)</b>	Impervious	Excellent	Resistant to oxidation, carburization & sulphidation	1300	1350	1200
<b>NiCr alloy (Inconel)</b>	Impervious	Excellent	Good high temperature oxidation resistance combined with good resistance in carburising and chloride containing environments	1100	1100	750
<b>High temperature stainless steel 1.4841 (314)</b>	Impervious	Excellent	Good oxidation resistance	1100	1100	600

**i** Please note:

- Long unsupported horizontal work tubes will bend at high temperatures

## Calibration certificates

The following calibration options can be supplied, each of which is available with a certificate from a UKAS accredited laboratory, which is traceable to a UK national standard

- UKAS traceable certificate for the thermocouple only, calibrated at 3 temperature points, specified by the customer
- UKAS traceable certificate for the temperature controller only, calibrated at 3 temperature points at temperatures specified by Carbolite Gero
- UKAS traceable certificate at 3 temperature points for both thermocouple & temperature controller
- For advice and specifications to comply with AMS2750E (Nadcap) for heat treatment applications, please contact Carbolite Gero

## Work tube packages

### Air, gas atmosphere and vacuum work tube packages for TF, TS & TG tube furnaces

Work tube packages are listed in the optional accessories section of each tube furnace, with the intention of providing a 'quick ordering' system for combining the accessories required for the specified application. Each package comprises a work tube of the specified diameter with insulation plugs or heat shields appropriate for the operating atmosphere. A pair of end seals is included in the gas atmosphere and vacuum packages. A 3 mm diameter probe thermocouple is included in all work tube packages for furnaces up to 1200 °C, for connection to a separate display or recorder. Above 1200 °C one end seal will have a 10 mm diameter thermocouple gland with blanking plug to suit a probe thermocouple (probe thermocouple must be ordered separately).

#### The work tube material in the packages are:

- For TF, TS & TG 1200 °C furnaces there is a choice of mullite C610 / IAP or quartz.
- For TF 1600 °C furnaces there is a choice of RCA or mullite C610 / IAP.

See work tube selection guide on page 41 for maximum temperature limits.

**Alternatives to these packages can be created by selecting appropriate individual components.**

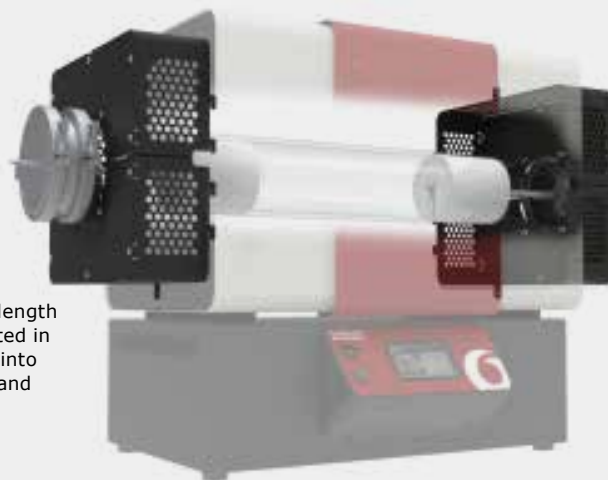

Work tube packages with extended length work tubes include guards as indicated in this image. The guards simply hook into the end plates of the tube furnaces and are each fixed with one screw.

### Work tube package for air

Tube furnace work tube package for air contains:



- 1) Standard length work tube
- 2) 2 x insulation plugs for standard length work tube
- 3) Support bracket for insulation plugs & thermocouple
- 4) Probe thermocouple access:
  - a: Up to 1200 °C:  
Probe thermocouple gland complete with type N thermocouple
  - b: Above 1200 °C:  
10 mm gland with PTFE seal and blanking plug to suit optional type R or B or 20/40 probe thermocouple assembly

## Work tube package for gas atmosphere

The work tube package for gas atmosphere is suitable for either inert gas or hydrogen atmosphere. If use with hydrogen a gas safety system **MUST** be used (see page 48).

Tube furnace work tube package for gas atmosphere contains:

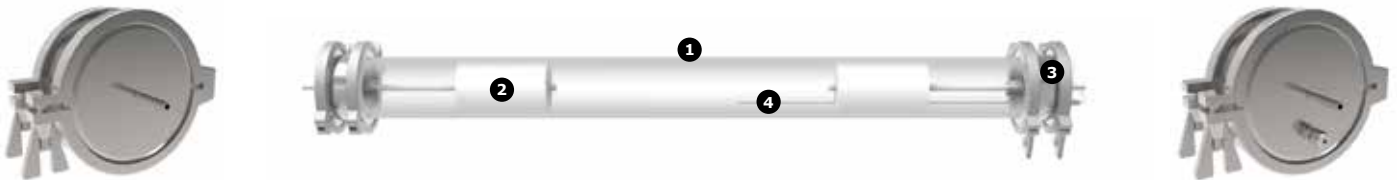

- 1) Extended length work tube
- 2) 2 x insulation plugs for extended length work tube
- 3) Work tube end seals:
  - 1 x gas inlet/outlet pipe
  - 1 x gas inlet/outlet pipe + thermocouple gland
- 4) Probe thermocouple access:
  - a: Up to 1200 °C:  
Probe thermocouple gland complete with type N thermocouple
  - b: Above 1200 °C:  
10 mm gland with PTFE seal and blanking plug to suit optional type R or B or 20/40 probe thermocouple assembly

## Work tube package for vacuum atmosphere

Available for work tube outer diameters 60, 86, 125, 150, 200 mm.

Tube furnace work tube package for vacuum atmosphere is suitable for vacuum pressure to  $5 \times 10^{-2}$  mbar or  $1 \times 10^{-5}$  mbar depending on type of vacuum pump used (page 46) and contains:

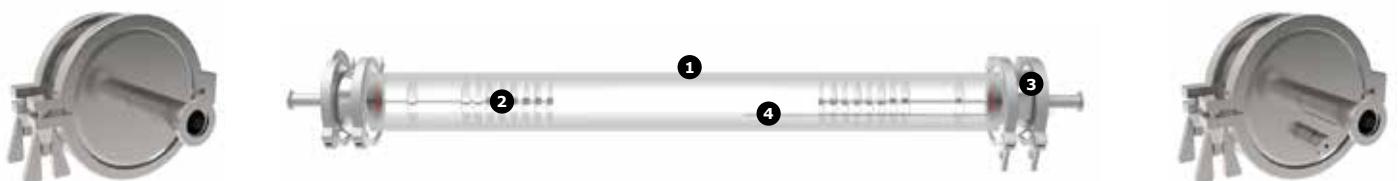

- 1) Extended length work tube
- 2) 2 x radiation shields
- 3) Work tube end seals:
  - 1 x NW16 vacuum flange + thermocouple gland
  - 2 x end plates: 1 x NW25 (compatible with low vacuum pump package); 1 x NW40 for 60 mm work tube outer diameter or 1 x ISO-K 63 for 86, 125, 150 & 200 mm work tube outer diameters (compatible with high vacuum pump package)
- 4) Probe thermocouple access:
  - a: Up to 1200 °C:  
Probe thermocouple gland complete with type N thermocouple
  - b: Above 1200 °C:  
10 mm gland with PTFE seal and blanking plug to suit optional type R or B or 20/40 probe thermocouple assembly

**NOTE:** For hydrogen atmosphere a gas safety system **MUST** be used (see page 48).



**To ensure the correct accessories are supplied, please specify the furnace model (horizontal or vertical use), work tube dimensions (inner diameter, outer diameter and length) and operating temperature.**

## Ceramic insulation plugs

Ceramic insulation plugs are designed to reduce heat loss from tube ends and improve temperature uniformity. They are particularly helpful for vertical tubes and tubes with diameters greater than 25 mm. Different insulation plugs are supplied for use with standard length work tubes (for use in air) and extended length work tubes (for use with modified atmosphere and vacuum). In vertical work tubes, insulation plug supports are required unless used with work tube end seals (see below).

Insulation plugs include metallic hangers which allow vertical use and a groove for thermocouple access.

The insulation plugs supplied will be appropriate for the furnace and application.



Insulation plug

## Radiation shields

In extended work tubes radiation shields can be used as an alternative to insulation plugs.

Specifically useful for dust free applications and with vacuum levels lower than  $10^{-3}$  mbar. Up to a maximum operating temperature of 1200 °C the shields are constructed from metal, and above this temperature from ceramic. In vertical work tubes, radiation shield supports are required unless used with work tube end seals (see below).

Radiation shields include metallic hangers which allow vertical use and a groove for thermocouple access.

The shields supplied will be appropriate for the furnace and application.



Radiation shield

## Work tube end seals

Work tube end seals are required to contain a modified atmosphere and for working with vacuum; vacuum levels of  $10^{-6}$  mbar are possible. These end seals are manufactured from stainless steel and are for use with extended work tubes only. They are available to fit work tubes with the following outside diameters: 32, 46, 60, 86, 100, 150 and 200 mm. Other sizes are available at additional cost.



End seal with gas nozzle (inlet/outlet)



End seal with NW40 vacuum flange



End seal with gas nozzle and thermocouple gland (1.5 mm)

The following fittings are available for use with the end seals: blank seal, gas nozzle (inlet/outlet), vacuum flanges (NW16, NW25, NW40 or ISO-K 63) and thermocouple glands (ø1.5 mm, 3 mm and 10 mm). Where the end seal diameter is large enough, combinations of the above fittings are possible, e.g. gas inlet/out nozzle + thermocouple gland. The end seals are designed for use in combination with insulation plugs or radiation shields. Water cooled end seals are available on request. To accommodate the additional weight of end seals, tube supports are included in the work tube packages.

## End seal details

- 1) Clamp
- 2) Seal plate
- 3) 'O' ring seal
- 4) Seal sleeve
- 5) Clamp seal
- 6) End plate

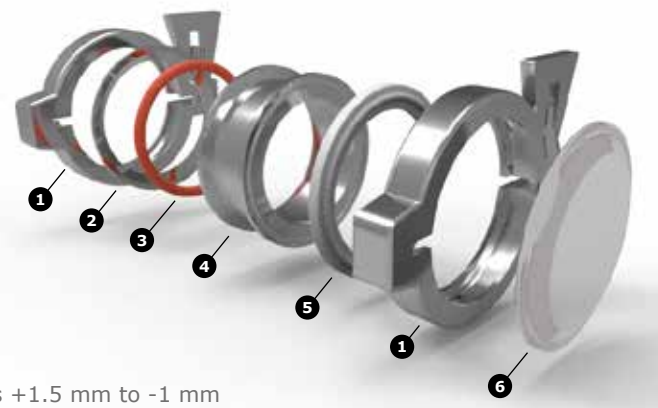

**NOTE:** The acceptable tolerance of the work tube outside diameter is +1.5 mm to -1 mm

## Accessories for Operation under Vacuum and Process Gas

For applications under vacuum or process gas, a comprehensive range of accessories is available for the F range, HTRH and HTRV tube furnaces. Tightly sealed, high purity  $Al_2O_3$  and  $Al_2O_3 / SiO_2$  tube materials, water cooled stainless steel flanges, and gas supply equipment allow for thermal treatment under specified atmospheres. In such treatment processes, the gas flow can be controlled either manually, with use of a flow meter, or automatically, with the use of a mass flow controller. Complete vacuum pumping systems, rotary vane pumps, turbomolecular pumps, data recording systems, and visualization software complete the product range.



Attachment housings can be secured to the furnace for convenient vacuum / protective gas operation. It is possible to fit up to two gas supply stations to these housings.



Upon request, tube furnaces of the F range, HTRH and HTRV can be supplied with a robustly welded frame with or without castors and control cabinet.



As some furnaces can be used horizontally as well as vertically, an extra stand is available that is specifically designed to guarantee a safe working environment in any position.



Vacuum pumps or complete pumping systems with the appropriate measuring technology.



The furnace types F range, HTRH and HTRV can be provided with protective gas equipment or vacuum/protective gas equipment.



Equipment flanges can be furnished with fast clamping seals.



Water cooled stainless steel flange



Radiation protection packaging flange

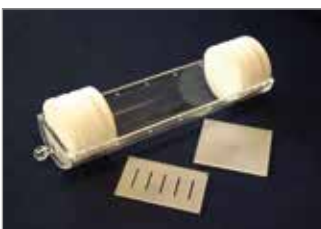

In response to customer demand, sample carriers for wafers or sample attachments of various materials are available.



For loading samples, sample boats and crucibles are available in various sizes and materials.



A comprehensively fitted, protective gas supply on a mounting plate or as an installation component are designed for laboratory customers.

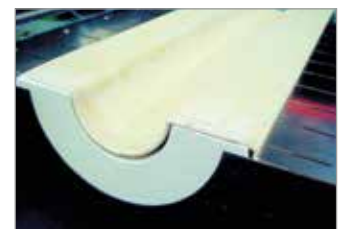

For split tube furnaces we offer robustly shaped ceramic panels to protect the heating elements and for sample holding.

## Vacuum pump packages

**Carbolite Gero offers vacuum pumps or complete pumping systems with the appropriate vacuum measuring technology.**

A vacuum pump package consists of vacuum pump, flowmeter for inert gas, vacuum gauge, vacuum tight valve, bypass for fast purging, gas outlet valve and safety overpressure valve. The appropriate vacuum pump package must be selected to ensure compatibility between the height of the furnace work tube and the vacuum pump. Combining a vacuum pump package with a work tube vacuum package (page 43) offers a complete solution for horizontal tube furnaces. Please contact Carbolite Gero for assistance.



Example of the turbo pump option for tube furnaces

In a cold, clean, dry and empty furnace the rotary vane pump option is able to reach a vacuum level of  $5 \times 10^{-2}$  mbars, the turbo pump option reaches under the same conditions  $1 \times 10^{-5}$  mbars.

The rotary vane pump is a pre vacuum pump and is the most frequently used pump. The pump is used for direct evacuation of atmospheric pressure with a rotating speed of approximately 1,500 turns per minute via a radial, movable plug. The vacuum chamber of the pump is greased with oil.

### Standard features

#### Rotary vane pump package:

- Double stage rotary vane pump with a pumping rate of 4 m<sup>3</sup>/h
- Pirani gauge
- Vacuum tight valve
- Flowmeter for use with inert gas
- Bypass for fast purging
- Gas outlet valve
- Safety overpressure valve

#### Turbo pump package:

- 1) Turbo pump with a pumping rate of 65 l/s
  - Rotary vane pump as pre pump
- 2) Full range vacuum gauge
- 3) Vacuum tight valve
- 4) Flowmeter for use with inert gas
  - Bypass for fast purging
- 5) Gas outlet valve
- 6) Safety overpressure valve

The turbomolecular pump consists of stators between several high speed rotors. The rotational speed is about 90,000 revolutions per minute. At these speeds, the rotor is now in the range of the particle velocity enabling gas to be pushed through the pump. When combined with a pre-vacuum pump, the achievable vacuum level is in the high vacuum range or better. Turbomolecular pumps are the most convenient and frequently used pumps for high and ultra-high vacuum operation. Very high atmospheric purity of the furnace chamber is achieved as the pump easily removes heavy, slow particles, such as hydrocarbons, and maintains the high speeds needed to evacuate light, fast moving particles.

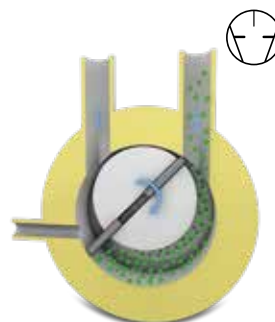

Rotary vane pump

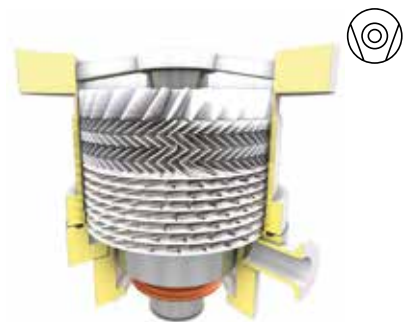

Turbomolecular pump

## Inert gas packages

**These inert gas packages have been designed to work in combination with the gas atmosphere work tube packages to optimise the inert atmosphere inside the work tube. Allowable gases are shown in the table. They are not suitable for flammable gases such as hydrogen or oxygen.**

The standard inert gas package includes a manual on/off valve along with pressure gauge and flow meter. The advanced inert gas package has the addition of an electrically operated valve which can be activated by a program segment output or temperature alarm.

## Gases and flow ranges

Gas	Flow range
Air	1-10 l/min
Nitrogen N2	1-10 l/min
Argon Ar	1-8 l/min
95% N2 / 5% H2	1.2-11 l/min
98% Ar / 2% H2	1-9 l/min
Carbon dioxide CO2	1-8.5 l/min
Helium He	2-20 l/min

### The standard inert gas package includes:

- Gas inlet = 6 mm outside diameter push in fitting
- Manual on/off ball valve
- Pressure gauge
- Flow meter with flow adjustment knob
- Non-return valve
- Fitting and pipe to connect an additional inert gas package
- Gas outlet = 6 mm braided hose with 6 mm union
- Dimensions: H x W x D (mm): 240 x 135 x 215

### The advanced inert gas package includes:

- Gas inlet = 6 mm OD push in fitting
- Manual on/off ball valve
- Pressure gauge
- Electrically operated valve
- Flow meter with flow adjustment knob
- Non-return valve
- Fitting and pipe to connect an additional inert gas package
- Gas outlet = 6 mm braided hose with 6 mm union
- Dimensions: H x W x D (mm): 240 x 135 x 215



**NOTE:** Please select (from the price list) the appropriate advanced inert gas package to specify if the electrically operated valve is activated by either program segment output or temperature alarm.

Multiple gas packages can be used together and have the facility for the user to fix them together to make a combined assembly.

If the temperature controller is an EPC3016P1 or CC-T1 a maximum of two advanced inert gas packages can be combined.

If the temperature controller is an EPC3008P10 or nanodac a maximum of three advanced inert gas packages can be combined.



# Laboratory gas safety system

**The laboratory gas safety system is required for safe operation when using hydrogen gas in Carbolite Gero tube furnaces or metallic chamber retorts.**

The system is suitable for use with either tube furnaces using a suitable work tube package or chamber furnaces using an A105 retort up to a maximum internal volume of 50 litres.

The system is supplied with its own control cabinet, off gas burner and flexible pipes with fittings to connect directly to a gas atmosphere work tube package or chamber A105 retort.

The system automatically purges the work tube or chamber with nitrogen, ensures hydrogen is only introduced to the furnace above a safety temperature of 800°C, and provides an end purge of nitrogen. A nitrogen purge also occurs in the event of unplanned shutdowns.

Two adjustable flow meters provide the facility for hydrogen and nitrogen flows to be blended to suit the process.

A monitored electrically heated gas ignitor ensures the hydrogen is fully consumed.

Safety features include:

- Over-pressure protection for the work tube or retort
- Excess flow (rupture) protection
- Purge timer
- Independent safety purge
- Supply gas monitoring
- Furnace temperature monitoring
- Electric ignitor



## Simplified piping schematic

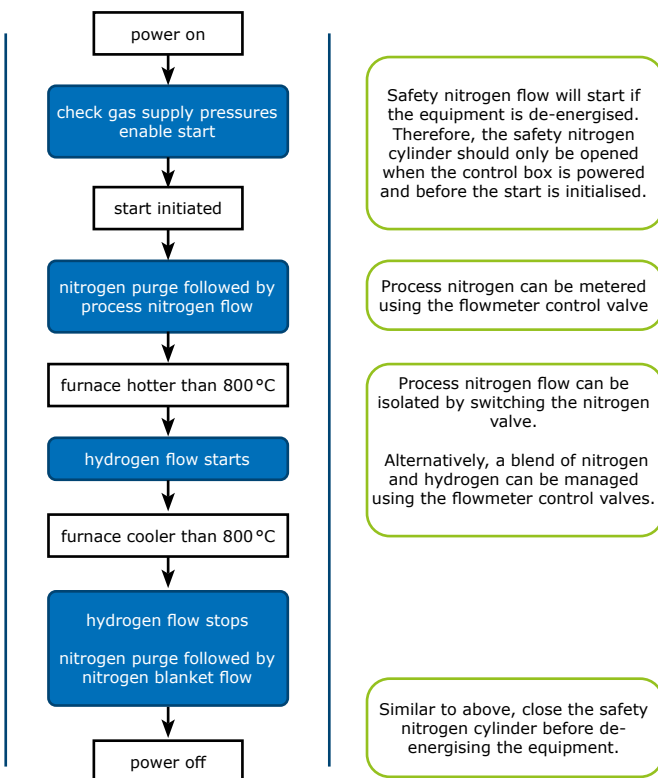
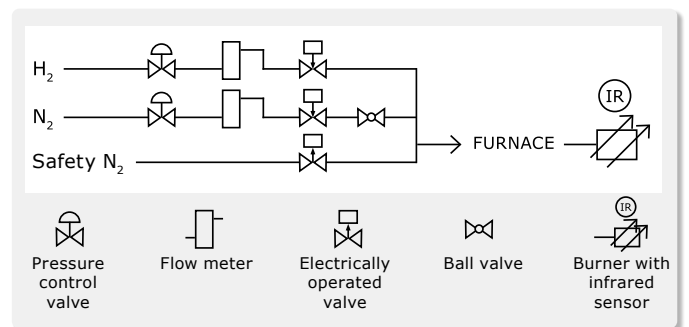

## Technical data

Model	Dimensions of control box H x W x D [mm]	Dimensions of burner assembly H x W x D [mm]	Power [W]
LGSS	440 x 430 x 490	650 x 300 x 335	300



# Tube furnaces with full safety equipment for special gas atmospheres e.g. hydrogen

In this example the hydrogen tube furnace system is based on the HTRH 16/100/600 tube furnace. It is designed to meet all required regulations for the safe handling of hydrogen gas. Other gases such as chlorine, ammonia, methane or other hydrocarbon gases, CO, CO<sub>2</sub> and H<sub>2</sub>S are available as well.

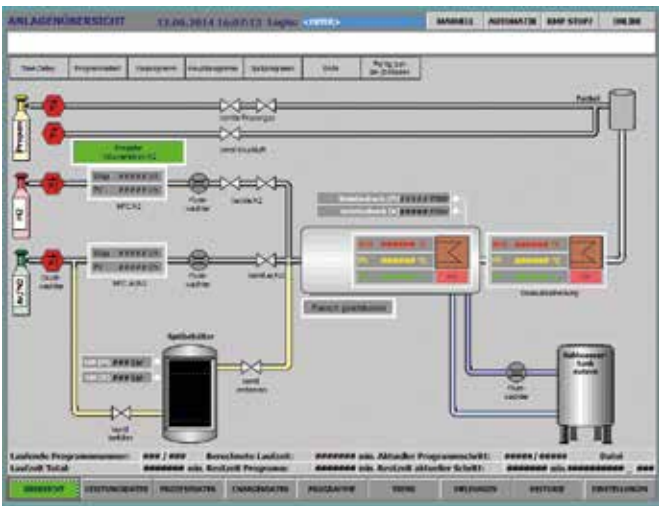

A touch panel interface is used for automated operation. All valves, temperatures, gas flows, etc. can be switched on and off manually or automatically by a predetermined program.



The purging tank is filled with inert nitrogen at a pressure of 8 bar. The purging tank is a required safety option when working with pure hydrogen or other dangerous gases. In case of an emergency this tank provides enough inert gas for purging the whole furnace multiple times to ensure that no dangerous gas remains in the furnace.

HTRH 16/100/600: Hydrogen tube furnace with a heated length of 600 mm up to 1600°C. Operation under pure hydrogen is possible. All necessary safety provisions are implemented.

- 1) Hydrogen sensor
- 2) Afterburner
- 3) Heated gas outlet system
- 4) Touchpanel for automatic operation



The table below shows the standard power supply for products requiring an electrical supply more than 16 A single phase. Products not listed here can be used on a 220-240 V single phase 16 A supply. Other voltages on request. Please mention your preferred voltage in your enquiry. Upgrade prices may apply.

	Model	Volt	Phase	Ampere per phase
CGN	<b>AZ 13/32/360</b>	380-415	3 phase + N	max. 16A
CGN	<b>AZ 13/32/360</b>	other voltages and phases on request		
CGN	<b>AZ 13/50/430</b>	380-415	3 phase + N	max. 16A
CGN	<b>AZ 13/50/430</b>	other voltages and phases on request		
CGN	<b>AZ 13/80/810</b>	380-415	3 phase + N	max. 32A
CGN	<b>AZ 13/80/810</b>	other voltages and phases on request		
CGN	<b>AZ 13/110/1000</b>	380-415	3 phase + N	max. 63A
CGN	<b>AZ 13/110/1000</b>	other voltages and phases on request		
CGN	<b>FHA 13/32/200</b>	220-240	1 phase + N	max. 16A
CGN	<b>FHA 13/32/200</b>	other voltages and phases on request		
CGN	<b>FHA 13/32/500</b>	220-240	1 phase + N	max. 16A
CGN	<b>FHA 13/32/500</b>	other voltages and phases on request		
CGN	<b>FHA 13/50/200</b>	220-240	1 phase + N	max. 16A
CGN	<b>FHA 13/50/200</b>	other voltages and phases on request		
CGN	<b>FHA 13/50/500</b>	220-240	1 phase + N	max. 16A
CGN	<b>FHA 13/50/500</b>	other voltages and phases on request		
CGN	<b>FHA 13/50/750</b>	380-415	3 phase + N	max. 16A
CGN	<b>FHA 13/50/750</b>	other voltages and phases on request		
CGN	<b>FHA 13/80/200</b>	220-240	1 phase + N	max. 16A
CGN	<b>FHA 13/80/200</b>	other voltages and phases on request		
CGN	<b>FHA 13/80/500</b>	380-415	3 phase + N	max. 16A
CGN	<b>FHA 13/80/500</b>	other voltages and phases on request		
CGN	<b>FHA 13/80/750</b>	380-415	3 phase + N	max. 32A
CGN	<b>FHA 13/80/750</b>	other voltages and phases on request		
CGN	<b>FHA 13/80/1000</b>	380-415	3 phase + N	max. 32A
CGN	<b>FHA 13/80/1000</b>	other voltages and phases on request		
CGN	<b>FHA 13/110/500</b>	380-415	3 phase + N	max. 32A
CGN	<b>FHA 13/110/500</b>	other voltages and phases on request		
CGN	<b>FHA 13/110/750</b>	380-415	3 phase + N	max. 63A
CGN	<b>FHA 13/110/750</b>	other voltages and phases on request		
CGN	<b>FHA 13/110/1000</b>	380-415	3 phase + N	max. 63A
CGN	<b>FHA 13/110/1000</b>	other voltages and phases on request		
CGN	<b>FHA 13/110/1250</b>	380-415	3 phase + N	max. 63A
CGN	<b>FHA 13/110/1250</b>	other voltages and phases on request		
CGN	<b>FHC 13/32/500</b>	220-240	1 phase + N	max. 16A
CGN	<b>FHC 13/32/500</b>	other voltages and phases on request		
CGN	<b>FHC 13/50/500</b>	220-240	1 phase + N	max. 16A
CGN	<b>FHC 13/50/500</b>	other voltages and phases on request		
CGN	<b>FHC 13/50/750</b>	380-415	3 phase + N	max. 16A
CGN	<b>FHC 13/50/750</b>	other voltages and phases on request		
CGN	<b>FHC 13/80/500</b>	380-415	3 phase + N	max. 16A
CGN	<b>FHC 13/80/500</b>	other voltages and phases on request		
CGN	<b>FHC 13/80/750</b>	380-415	3 phase + N	max. 32A
CGN	<b>FHC 13/80/750</b>	other voltages and phases on request		
CGN	<b>FHC 13/80/1000</b>	380-415	3 phase + N	max. 32A
CGN	<b>FHC 13/80/1000</b>	other voltages and phases on request		
CGN	<b>FHC 13/110/500</b>	380-415	3 phase + N	max. 32A
CGN	<b>FHC 13/110/500</b>	other voltages and phases on request		
CGN	<b>FHC 13/110/750</b>	380-415	3 phase + N	max. 63A
CGN	<b>FHC 13/110/750</b>	other voltages and phases on request		
CGN	<b>FHC 13/110/1000</b>	380-415	3 phase + N	max. 63A
CGN	<b>FHC 13/110/1000</b>	other voltages and phases on request		
CGN	<b>FHC 13/110/1250</b>	380-415	3 phase + N	max. 63A

	Model	Volt	Phase	Ampere per phase
CGN	<b>FHC 13/110/1250</b>	other voltages and phases on request		
CGN	<b>FST 13/40/200</b>	220-240	1 phase + N	max. 16A
CGN	<b>FST 13/40/200</b>	other voltages and phases on request		
CGN	<b>FST 13/70/500</b>	220-240	1 phase + N	max. 16A
CGN	<b>FST 13/70/500</b>	other voltages and phases on request		
CGN	<b>FST 13/100/500</b>	380-415	3 phase + N	max. 16A
CGN	<b>FST 13/100/500</b>	other voltages and phases on request		
CGN	<b>FST 13/100/1000</b>	380-415	3 phase + N	max. 32A
CGN	<b>FST 13/100/1000</b>	other voltages and phases on request		
CGN	<b>FST 13/150/1000</b>	380-415	3 phase + N	max. 63A
CGN	<b>FST 13/150/1000</b>	other voltages and phases on request		
CGN	<b>FZS 13/70/500</b>	220-240	1 phase + N	max. 16A
CGN	<b>FZS 13/70/500</b>	other voltages and phases on request		
CGN	<b>FZS 13/100/500</b>	380-415	3 phase + N	max. 16A
CGN	<b>FZS 13/100/500</b>	other voltages and phases on request		
CGN	<b>FZS 13/100/1000</b>	380-415	3 phase + N	max. 32A
CGN	<b>FZS 13/100/1000</b>	other voltages and phases on request		
CGN	<b>FZS 13/150/1000</b>	380-415	3 phase + N	max. 63A
CGN	<b>FZS 13/150/1000</b>	other voltages and phases on request		
CGN	<b>FZS 13/200/1000</b>	380-415	3 phase + N	max. 63A
CGN	<b>FZS 13/200/1000</b>	other voltages and phases on request		
CGN	<b>FZS 13/100/1500</b>	380-415	3 phase + N	max. 63A
CGN	<b>FZS 13/100/1500</b>	other voltages and phases on request		
CGN	<b>FZS 13/100/4500</b>	380-415	3 phase + N	max. 125A
CGN	<b>FZS 13/100/4500</b>	other voltages and phases on request		
CGN	<b>FZS 13/150/1500</b>	380-415	3 phase + N	max. 63A
CGN	<b>FZS 13/150/1500</b>	other voltages and phases on request		
CGN	<b>FZS 13/150/4500</b>	380-415	3 phase + N	max. 160A
CGN	<b>FZS 13/150/4500</b>	other voltages and phases on request		
CGN	<b>FZS 13/200/1500</b>	380-415	3 phase + N	max. 63A
CGN	<b>FZS 13/200/1500</b>	other voltages and phases on request		
CGN	<b>HTRH __/40/100</b>	220-240	1 phase + N	max. 16A
CGN	<b>HTRH __/40/100</b>	other voltages and phases on request		
CGN	<b>HTRH __/40/250</b>	220-240	1 phase + N	max. 16A
CGN	<b>HTRH __/40/250</b>	other voltages and phases on request		
CGN	<b>HTRH __/40/500</b>	380-415	3 phase + N	max. 32A
CGN	<b>HTRH __/40/500</b>	other voltages and phases on request		
CGN	<b>HTRH __/70/150</b>	380-415	3 phase + N	max. 16A
CGN	<b>HTRH __/70/150</b>	other voltages and phases on request		
CGN	<b>HTRH __/70/300</b>	380-415	3 phase + N	max. 16A
CGN	<b>HTRH __/70/300</b>	other voltages and phases on request		
CGN	<b>HTRH __/70/600</b>	380-415	3 phase + N	max. 32A
CGN	<b>HTRH __/70/600</b>	other voltages and phases on request		
CGN	<b>HTRH __/100/150</b>	380-415	3 phase + N	max. 16A
CGN	<b>HTRH __/100/150</b>	other voltages and phases on request		
CGN	<b>HTRH __/100/300</b>	380-415	3 phase + N	max. 32A
CGN	<b>HTRH __/100/300</b>	other voltages and phases on request		
CGN	<b>HTRH __/100/600</b>	380-415	3 phase + N	max. 32A
CGN	<b>HTRH __/100/600</b>	other voltages and phases on request		
CGN	<b>HTRH __/150/600</b>	380-415	3 phase + N	max. 32A
CGN	<b>HTRH __/150/600</b>	other voltages and phases on request		
CGN	<b>HTRH __/200/600</b>	380-415	3 phase + N	max. 63A
CGN	<b>HTRH __/200/600</b>	other voltages and phases on request		

	Model	Volt	Phase	Ampere per phase
CGN	<b>HTRH-3 __/70/600</b>	380-415	3 phase + N	max. 32A
CGN	<b>HTRH-3 __/70/600</b>	other voltages and phases on request		
CGN	<b>HTRH-3 __/100/600</b>	380-415	3 phase + N	max. 32A
CGN	<b>HTRH-3 __/100/600</b>	other voltages and phases on request		
CGN	<b>HTRH-3 __/100/900</b>	380-415	3 phase + N	max. 63A
CGN	<b>HTRH-3 __/100/900</b>	other voltages and phases on request		
CGN	<b>HTRH-3 __/150/600</b>	380-415	3 phase + N	max. 32A
CGN	<b>HTRH-3 __/150/600</b>	other voltages and phases on request		
CGN	<b>HTRH-3 __/150/900</b>	380-415	3 phase + N	max. 80A
CGN	<b>HTRH-3 __/150/900</b>	other voltages and phases on request		
CGN	<b>HTRV __/40/100</b>	220-240	1 phase + N	max. 16A
CGN	<b>HTRV __/40/100</b>	other voltages and phases on request		
CGN	<b>HTRV __/40/250</b>	220-240	1 phase + N	max. 16A
CGN	<b>HTRV __/40/250</b>	other voltages and phases on request		
CGN	<b>HTRV __/40/500</b>	380-415	3 phase + N	max. 32A
CGN	<b>HTRV __/40/500</b>	other voltages and phases on request		
CGN	<b>HTRV __/70/250</b>	380-415	3 phase + N	max. 16A
CGN	<b>HTRV __/70/250</b>	other voltages and phases on request		
CGN	<b>HTRV __/70/500</b>	380-415	3 phase + N	max. 32A
CGN	<b>HTRV __/70/500</b>	other voltages and phases on request		
CGN	<b>HTRV __/100/250</b>	380-415	3 phase + N	max. 16A
CGN	<b>HTRV __/100/250</b>	other voltages and phases on request		
CGN	<b>HTRV __/100/500</b>	380-415	3 phase + N	max. 32A
CGN	<b>HTRV __/100/500</b>	other voltages and phases on request		
CGN	<b>HTRV __/100/500</b>	other voltages and phases on request		
CGN	<b>HTRV __/150/250</b>	380-415	3 phase + N	max. 32A
CGN	<b>HTRV __/150/250</b>	other voltages and phases on request		
CGN	<b>HTRV __/150/500</b>	380-415	3 phase + N	max. 63A
CGN	<b>HTRV __/150/500</b>	other voltages and phases on request		
CGN	<b>HTRV __/200/250</b>	380-415	3 phase + N	max. 32A
CGN	<b>HTRV __/200/250</b>	other voltages and phases on request		
CGN	<b>HTRV __/200/500</b>	380-415	3 phase + N	max. 63A
CGN	<b>HTRV __/200/500</b>	other voltages and phases on request		
CGN	<b>HTRV-A __/70/120</b>	380-415	3 phase + N	max. 16A
CGN	<b>HTRV-A __/70/120</b>	other voltages and phases on request		
CGN	<b>HTRV-A __/70/250</b>	380-415	3 phase + N	max. 16A
CGN	<b>HTRV-A __/70/250</b>	other voltages and phases on request		
CGN	<b>HTRV-A __/70/500</b>	380-415	3 phase + N	max. 32A
CGN	<b>HTRV-A __/70/500</b>	other voltages and phases on request		
CGN	<b>HTRV-A __/70/700</b>	380-415	3 phase + N	max. 63A
CGN	<b>HTRV-A __/70/700</b>	other voltages and phases on request		
CGN	<b>HTRV-A __/100/500</b>	380-415	3 phase + N	max. 32A
CGN	<b>HTRV-A __/100/500</b>	other voltages and phases on request		
CGN	<b>HTRV-A __/100/700</b>	380-415	3 phase + N	max. 63A
CGN	<b>HTRV-A __/100/700</b>	other voltages and phases on request		
CGH	<b>RHST 600</b>	220 - 240	single phase	17
CGH	<b>RHST 600</b>	380 - 415	3 phase + N	5
CGH	<b>RHST 600</b>	200 - 240	3 phase delta	10
CGH	<b>RHST 900</b>	220 - 240	single phase	25
CGH	<b>RHST 900</b>	380 - 415	3 phase + N	8
CGH	<b>RHST 900</b>	200 - 240	3 phase delta	14
CGH	<b>RHZE 600</b>	220 - 240	single phase	17
CGH	<b>RHZE 600</b>	380 - 415	3 phase + N	5
CGH	<b>RHZE 600</b>	200 - 240	3 phase delta	10

	Model	Volt	Phase	Ampere per phase
CGH	<b>RHZE 900</b>	220 - 240	single phase	25
CGH	<b>RHZE 900</b>	380 - 415	3 phase + N	8
CGH	<b>RHZE 900</b>	200 - 240	3 phase delta	14
CGH	<b>TF1 12/125/1000</b>	220-240	1 phase + N	20
CGH	<b>TF1 12/125/1000</b>	200-240	3 phase delta	16
CGH	<b>TF1 12/125/1000</b>	380-415	3 phase + N	10
CGH	<b>TF1 12/125/1200</b>	220-240	1 phase + N	25
CGH	<b>TF1 12/125/1200</b>	200-240	3 phase delta	16
CGH	<b>TF1 12/125/1200</b>	380-415	3 phase + N	16
CGH	<b>TF3 12/125/1000</b>	220-240	1 phase + N	20
CGH	<b>TF3 12/125/1000</b>	200-240	3 phase delta	16
CGH	<b>TF3 12/125/1000</b>	380-415	3 phase + N	10
CGH	<b>TF3 12/125/1200</b>	220-240	1 phase + N	25
CGH	<b>TF3 12/125/1200</b>	200-240	3 phase delta	16
CGH	<b>TF3 12/125/1200</b>	380-415	3 phase + N	16
CGH	<b>TF1 16/60/180</b>	110-120	1 phase + N	32
CGH	<b>TF1 16/60/180</b>	220-240	1 phase + N	16
CGH	<b>TF1 16/60/300</b>	220-240	1 phase + N	25
CGH	<b>TF1 16/100/450</b>	220-240	1 phase + N	40
CGH	<b>TF1 16/100/450</b>	200-240	3 phase delta	25
CGH	<b>TF1 16/100/450</b>	380-415	3 phase + N	16
CGH	<b>TF1 16/100/600</b>	220-240	1 phase + N	50
CGH	<b>TF1 16/100/600</b>	200-240	3 phase delta	25
CGH	<b>TF1 16/100/600</b>	380-415	3 phase + N	16
CGH	<b>TF3 16/100/450</b>	220-240	1 phase + N	50
CGH	<b>TF3 16/100/450</b>	200-240	3 phase delta	32
CGH	<b>TF3 16/100/450</b>	380-415	3 phase + N	25
CGH	<b>TF3 16/100/600</b>	220-240	1 phase + N	50
CGH	<b>TF3 16/100/600</b>	200-240	3 phase delta	40
CGH	<b>TF3 16/100/600</b>	380-415	3 phase + N	32
CGH	<b>TS1 12/125/1000</b>	220-240	1 phase + N	20
CGH	<b>TS1 12/125/1000</b>	200-240	3 phase delta	16
CGH	<b>TS1 12/125/1000</b>	380-415	3 phase + N	10
CGH	<b>TS1 12/125/1200</b>	220-240	1 phase + N	25
CGH	<b>TS1 12/125/1200</b>	200-240	3 phase delta	16
CGH	<b>TS1 12/125/1200</b>	380-415	3 phase + N	16
CGH	<b>TS3 12/125/1000</b>	220-240	1 phase + N	20
CGH	<b>TS3 12/125/1000</b>	200-240	3 phase delta	16
CGH	<b>TS3 12/125/1000</b>	380-415	3 phase + N	10
CGH	<b>TS3 12/125/1200</b>	220-240	1 phase + N	25
CGH	<b>TS3 12/125/1200</b>	200-240	3 phase delta	16
CGH	<b>TS3 12/125/1200</b>	380-415	3 phase + N	16
CGH	<b>TS1 12/200/600</b>	220-240	1 phase + N	40
CGH	<b>TS1 12/200/600</b>	200-240	3 phase delta	25
CGH	<b>TS1 12/200/600</b>	380-415	3 phase + N	16
CGH	<b>TS1 12/200/1200</b>	200-240	3 phase delta	40
CGH	<b>TS1 12/200/1200</b>	380-415	3 phase + N	25
CGH	<b>TS3 12/200/600</b>	220-240	1 phase + N	40
CGH	<b>TS3 12/200/600</b>	200-240	3 phase delta	25
CGH	<b>TS3 12/200/600</b>	380-415	3 phase + N	16
CGH	<b>TS3 12/200/1200</b>	200-240	3 phase delta	40
CGH	<b>TS3 12/200/1200</b>	380-415	3 phase + N	25