



Gas Measurement Instruments Ltd

Gascoseeker 2-500 User Handbook

Issue 2

22/01/15

Part Number: 42476

INSTRUMENT SERIAL NUMBER

DATE OF ISSUE

<input type="text"/>	<input type="text"/>	<input type="text"/>	<input type="text"/>	<input type="text"/>	<input type="text"/>
----------------------	----------------------	----------------------	----------------------	----------------------	----------------------

ISSUED TO

RECORD OF INSPECTIONS

DATE	WORKSHOP	INSPECTED BY	CHECKED BY

GMI welcomes comments on all our publications. Your comments can be of great value in helping us to improve our customer publications. Please send any comments that you have to our Customer Support Department at GMI.

COPYRIGHT

This User Handbook is copyright of Gas Measurement Instruments Ltd (GMI) and the information contained within, is for use only with the Gascoseeker 2-500 instrument. Reproduction, in whole or in part, including utilisation in machines capable of reproduction or retrieval without written permission of Gas Measurement Instruments Ltd is prohibited. Reverse engineering is not permitted.

LIABILITY

Every care has been taken in the preparation of this document, but GMI Ltd do not accept any responsibility for errors or omissions and their consequences. Information in this document is subject to change without notice. This document does not constitute a specification or basis for a contract. Your statutory rights under law are not affected.

MODIFICATION NOTICES

GMI aim to notify customers of relevant changes in the product operation and maintain this manual up to date. In view of the policy of continuous product improvement there may be operational differences between the latest product and this manual.

This Handbook is an important part of the Gascoseeker 2-500 product. Please note the following points:

- It should be kept with the instrument for the life of the product.
- Amendments should be attached.
- This Handbook should be passed on to any subsequent owner/user of the instrument.
- Although every care is taken in the preparation of this Handbook it does not constitute a specification for the instrument.



SOFTWARE

Software supplied on EPROM or similar device for use in a particular product, may only be used in that product and may not be copied without the written permission of Gas Measurement Instruments Ltd. Reproduction or disassembly of such embodied programmes or algorithms is prohibited. Ownership of such software is not transferable and GMI Ltd does not warrant that the operation of the software will be error free or that the software will meet the customer's requirements.

DISPOSAL ADVICE

When no longer in use, dispose of the instrument carefully and with respect for the environment. GMI will dispose of the instrument without charge if returned to the factory.

SAFETY

- The instrument must be regularly serviced and calibrated by fully trained personnel in a safe area.
- **Batteries:** Alkaline batteries must be exchanged in a safe area and fitted correctly before use. Never use damaged batteries or expose to extreme heat.
- Only GMI replacement parts should be used.
- If the instrument detects gas, follow your own organisation's procedures and operational guidelines.
- The combustion chamber is a flameproof assembly and must not be opened in the presence of a flammable atmosphere.
- Gasurveyor 500 series instruments are certified as EEx iad IIC T4 (-20°C ≤ Tamb ≤ 50°C), BAS01ATEX2292   II 2 G. UL Class 1 Groups A, B, C and D.
- This equipment is designed and manufactured to protect against other hazards as defined in paragraph 1.2.7 of Annex II of the ATEX Directive 94/9/EC

Any right of claim relating to product liability or consequential damage to any third party against GMI is removed if the warnings are not observed.

AREAS OF USE

Exposure to certain chemicals can result in a loss of sensitivity of the flammable sensor. Where such environments are known or suspected it is recommended that more frequent response checks are carried out. The chemical compounds that can cause loss of sensitivity include Silicones, Lead, Halogens and Sulphur. Do not use instrument in potentially hazardous atmospheres containing greater than 21% Oxygen. The enclosure material is polypropylene and must not be exposed to environments which are liable to result in mechanical or thermal degradation or to damage caused by contact with aggressive substances. Additional protection may be required in environments where the instrument enclosure is liable to damage.

STORAGE, HANDLING AND TRANSIT

The batteries should be removed if the instrument is stored for longer than 3 months. The instrument is designed to handle harsh environments. The sensing elements are sealed to IP54 and the rest of the instrument to IP64. If not subject to misuse or malicious damage, the instrument will provide many years of reliable service.

REVISION RECORD

Date	Pages	Description Of Change
Issue 1 26/08/03	All	New User Handbook
Issue 2 22/01/15	36	Revised to include effect of CN 6445

CONTENTS

COPYRIGHT	i
LIABILITY	i
MODIFICATION NOTICES	i
SOFTWARE	i
DISPOSAL ADVICE	i
SAFETY	ii
AREAS OF USE	ii
STORAGE, HANDLING AND TRANSIT	ii

REVISION RECORD	iii
-----------------------	-----

GENERAL	1
% LEL	2
% Volume Gas	2
Operation	3

CONSTRUCTION	4
--------------------	---

RANGES OF OPERATION	5
% LEL Range	5
% Gas Range	5
LEL Range Display	6

SENSOR LIFE	8
-------------------	---

SPECIFICATION	9
---------------------	---

OPERATING PROCEDURE	10
---------------------------	----

CALIBRATION	11
-------------------	----

BEFORE USE	12
------------------	----

MEASURE MODE	13
1. Switch ON	13
2. Ready For Use	15
3. Sample Start	15
4. Sample Finish	16
5. Switch Off	17

ZERO MODE	19
-----------------	----

OPERATOR MESSAGES	22
SAMPLE	22
OFF	22
SAMPLE FAULT	22
ZERO FAULT	22
BAT 'Flashing'	22
BAT FAULT	22
ZERO	22

PROBE	23
-------------	----

SAMPLE LINE	29
-------------------	----

LEL / GAS MEASUREMENTS	30
Relationship of LEL and % Methane in Air	30
% LEL (Lower Explosive Limit)	30
% UEL (Upper Explosive Limit)	30
% GAS	30

BATTERY LIFE	32
Battery Safety Code	34

Battery Replacement	36
---------------------------	----

ASPIRATOR BULB	40
----------------------	----

Carrying Straps	43
-----------------------	----

WAISTBAND HARNESS	46
-------------------------	----

INSTRUMENT COTTON FILTER.....	47
-------------------------------	----

FAULT FINDING	49
Fault Finding	52
INSTRUMENT WILL NOT SWITCH ON	52
INSTRUMENT WILL NOT SWITCH OFF	54
BAT FLAG OPERATES AFTER SHORT TIME	55
BATTERIES DO NOT GIVE LONG USE	56
BAR GRAPH ON BATTERY TEST DOES NOT INDICATE 100% AFTER FITTING NEW BATTERIES	58

SAMPLE FAULT KEEPS OPERATING	59
ZERO FAULT FLAG OPERATES	61
CHECK ZERO FLAG OPERATES	63
BACKGROUND ILLUMINATION DOES NOT OPERATE	64
INSTRUMENT SWITCHES ON AND IMMEDIATELY SWITCHES OFF	65
INSTRUMENT STARTS CORRECTLY BUT SWITCHES OFF WHEN PUMP OPERATED	67
INSTRUMENT DOES NOT OPERATE ON DEPOT CHECKER	68
GAS RESPONSE IS SLOW	70
INSTRUMENT DOES NOT CHANGE RANGE	71
NO NUMBERS ON DIGITAL DISPLAY	73

INDEX	I
-------------	---

GENERAL

The G.M.I. Gascoseeker 2-500 has been designed as a replacement for the successful Gascoseeker Mk 2 instrument for the measurement of % LEL and % Volume Gas.



This handbook describes the operation and user maintenance of the instrument.

The instrument has two basic measuring ranges.

- % LEL
- % VOLUME GAS

% LEL

The % L.E.L. (Lower Explosive Limit) range indicates the explosibility of the flammable gases in the sample. In the case of METHANE (NATURAL GAS) 100% L.E.L. represents 5% by volume Methane in air. On this range the operating principle is a catalyst reaction and the instrument measures the heat developed by the combustion of the flammable portion of the atmosphere under test.

% Volume Gas

The % Volume Gas range indicates the total Volume of a specific gas, usually METHANE (NATURAL GAS) present with respect to air and is scaled over the complete range 0 - 100% Volume Gas. On this range the operating principle of the detection system is thermal conductivity.

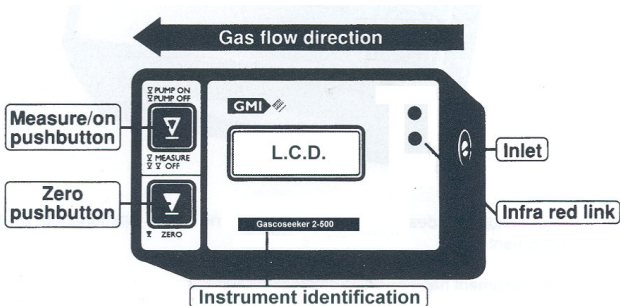

Operation

A sample of the atmosphere to be measured is drawn through the instrument by means of a pump via a filter into the analysing chamber. The analysing chamber contains the detection elements which monitor the gas.

Range selection is automatic.

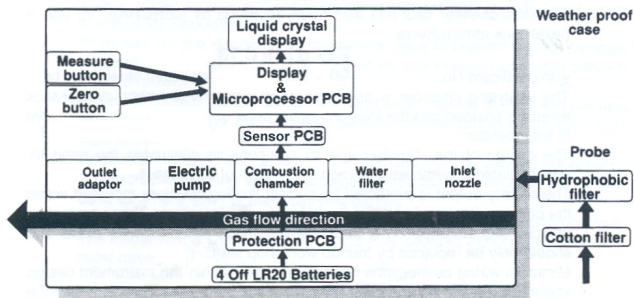

The total system is controlled by a microprocessor which maintains the necessary voltage conditions on the sensing elements, controls the pump and range selection and displays the result on a solid state analogue and digital display.

The microprocessor carries out some housekeeping and status management functions for the instrument and the instrument status is also shown on the display as is the range selected. The display is back illuminated when used in low ambient light conditions.

The total instrument is housed in a tough impact resistant moulded case and is powered by size D LR20 alkaline cells to give up to 15 hours continuous operation.

CONSTRUCTION

The instrument is housed in a tough impact resistant moulded case.

The case material is carbon filled polycarbonate to reduce static risk and remove interference from radio or other equipment.

The top surface of the instrument is covered with stainless steel escutcheons which are marked with the necessary basic operating instructions.

These plates provide additional impact resistance and provide tough wear surfaces for everyday use.

Protection for the display is by toughened glass to prevent impact damage and the display itself is mounted on a shock absorbing mounting to prevent damage.

The instrument is sealed against dust and water ingress to IP54 and the use of plastic mouldings and stainless steel fastenings provide high corrosion resistance.

Additional markings and labelling are moulded into the case as necessary.

A detachable carrying strap is provided which can be varied in length and used as a neck sling or hand carrying handle.

Instrument operation is by sealed push-buttons on the instrument top plate.

The instrument is ATEX certified without any additional outer case.

RANGES OF OPERATION

% LEL Range

On the % LEL range, the instrument shows the flammable gas concentration up to 100% LEL which for METHANE (NATURAL GAS) represents 5% Volume Methane in Air.

The instrument calibration is shown on the instrument label i.e. METHANE

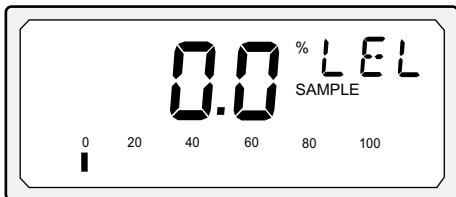

LEL Range Display

% Gas Range

On the % Gas range, the instruments are calibrated for use in METHANE and will give inaccurate results if used in other mixtures. In addition the instruments are calibrated for METHANE (NATURAL GAS) in Air mixtures and should only be used for such mixtures unless specially calibrated.

The instrument calibration is shown on the instrument label i.e. METHANE

On the % GAS range the instrument range is displayed in the top right hand corner of the L.C.D. as GAS.

From 0-10% GAS the digital display shows a decimal point and resolves the digital display to 0.5% GAS.

From 10% - 100% GAS the digital display shows a decimal point and resolves the signal to 1% GAS.

The analogue bar graph follows in 4% steps.

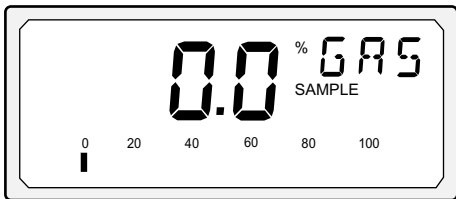

Gas Range Display

LEL Range Display

On the % LEL range the instrument range is displayed in the top right hand corner of the L.C.D. and the digital display will show 0-100% LEL.

From 0-10% LEL the digital display shows a decimal point and resolves the digital display to 0.5% LEL.

From 10% - 100% LEL the digital display shows a decimal point and resolves the signal to 1% LEL.

The analogue bar graph follows in 4% steps.

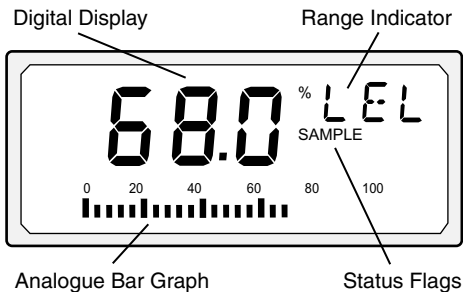

Digital Display with Instrument Measuring LEL Range

The LIQUID CRYSTAL DISPLAY (LCD) is protected by a toughened glass cover and is weatherproof.

Backlighting is provided automatically to enable the display to be seen under low ambient light conditions.

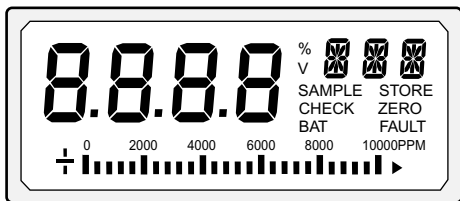

Digital Display with All Segments Activated

SENSOR LIFE

The sensors in the Gascoseeker 2-500 are manufactured to give improved stability and longer life and will operate many thousands of times with no effect on sensitivity or zero. Exposure to high concentrations of gas will not damage the elements.

The sensors are protected from water and dust damage by membrane and cotton filters.

Provided the instrument is correctly maintained and serviced, the sensors are guaranteed for 1 year in normal operation against the effects of zero drift and calibration deterioration within the instrument calibration span.

SPECIFICATION

Accuracy at N.T.P. for Methane (Natural Gas)

% LEL 2% Nominal +/- 1.5% L.E.L.

% Volume Gas 1% Nominal +/-1.0% GAS

(When calibrated at defined point on scale, due to lineariser function)

Temp. Range: -20 Deg.C to +50 Deg.C

Humidity 20% - 95% RH (non condensing)

Pressure 950 to 1100 mbar

Operating time: in excess of 15 hours continuous duty on LR20 batteries. (at normal ambient temperature)

Size: 180mm x 95mm x 105mm

Weight: 1.6 kilos including batteries

Note: The instrument should not be used in:

- a) Oxygen enriched atmospheres
- b) The presence of catalyst contaminants such as Silicones, Halogens and Halides, Tetraethyl lead, Antimony.

OPERATING PROCEDURE

The instrument should always be used as per the operating procedures for the operation being carried out.

IF IN DOUBT, ASK YOUR SUPERVISOR

CALIBRATION

The instrument has been calibrated for a particular gas mixture in air.

The calibration gas is identified by means of the calibration label on side of instrument.

Normally this would have “METHANE” written on it.

This signifies that the instrument is suitable for use in Methane (Natural Gas) in air atmospheres.

Other calibrations are possible but can only be set by competent persons in the instrument workshop.

These include Butane or Propane

The instrument can only be calibrated by competent persons in a suitably equipped instrument workshop or on a suitably programmed Depot Checker.

Before using instrument check that calibration / inspection label has a valid date.



BEFORE USE

The instrument should be checked before setting out for site to ensure that it is operational.

The detailed check procedures are given later in the manual, but a short summary is given below.

- Check BATTERIES have sufficient life left in them for your intended usage.
 - Check ZERO on instrument in clean air.
 - Check instrument has correct CALIBRATION for your usage.
 - Check instrument has no obvious FAULT conditions.
 - Check CALIBRATION is still valid.
 - Check ACCESSORIES.
 - Instrument supplied with the following as standard:
 - Carrying case
 - Handbook
 - Instruction Card
 - Battery compartment key
 - Probe handle complete with 1.5 metres sampling line, cotton filter and integral hydrophobic filter.
 - Long probe extension
 - Short probe extension
 - Carrying strap
 - Aspirator bulb
- (Waistband harness available as an accessory).

MEASURE MODE

1. Switch ON

Push MEASURE button ONCE to switch ON.

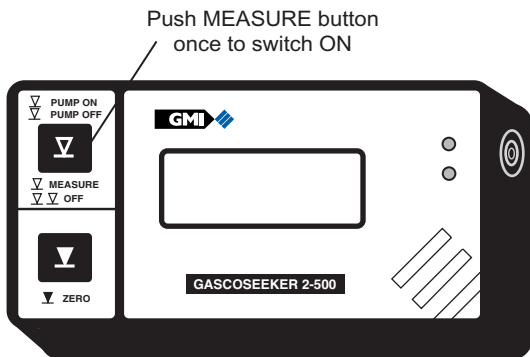

Instrument performs self check and energises all segments in display.

Pump also operates for a short period during this sequence.

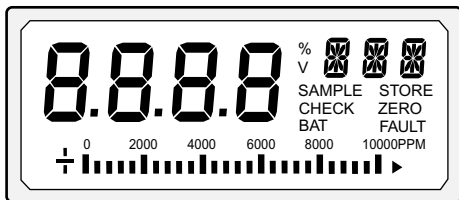

Display indicates instrument version identifier and software version number.

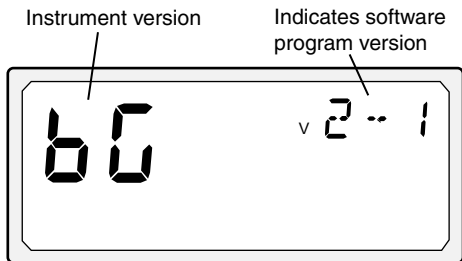

Bar graph indicates battery capacity and background illumination activated.

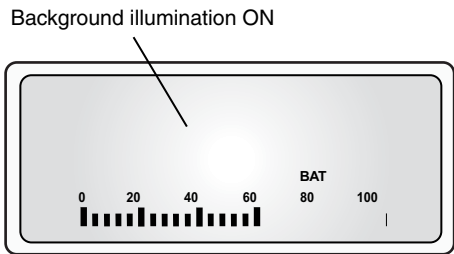

2. Ready For Use

After a few seconds the instrument is ready for use, indicated by a flashing DIGITAL display.

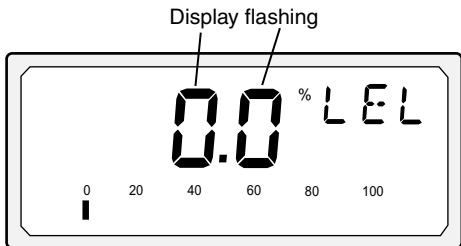

3. Sample Start

A single press of the MEASURE button when the pump is stopped starts the pump and draws the sample.

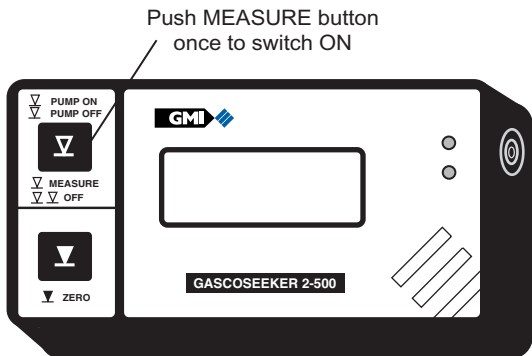

The sample flag indicates that the pump is running.

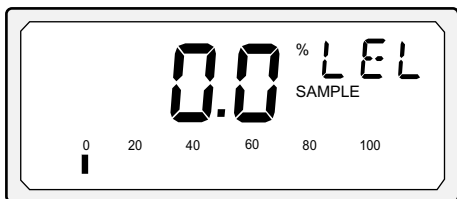

4. Sample Finish

A single press of the MEASURE button when the pump is running stops the pump and stops sampling.

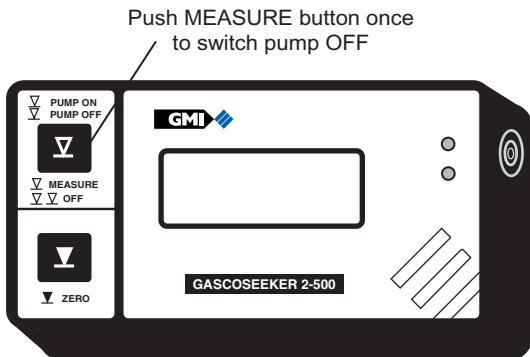

This is indicated by the absence of the SAMPLE flag and a flashing display.

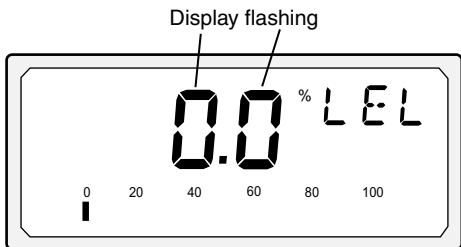

5. Switch Off

- (a) To switch off, depress MEASURE button twice in rapid succession.

OFF appears in the display and instrument will shut down.

To cancel, press MEASURE button ONCE.

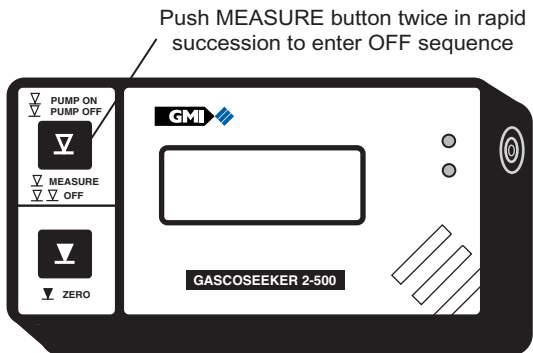

(b) Switch OFF is automatic after 30 minutes running.

OFF appears in the display before automatic switch off.

To cancel press MEASURE button ONCE.

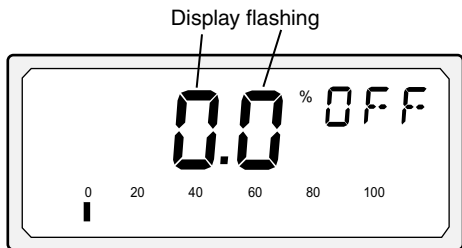

ZERO MODE

Make sure that the instrument is OFF and in FRESH AIR before zeroing.

Press the ZERO push-button once.

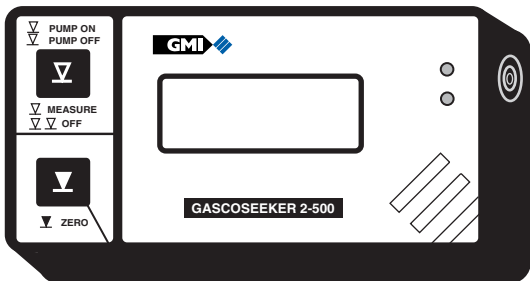

Push ZERO pushbutton once
to enter ZERO mode

The instrument will enter ZERO mode with similar test sequence to MEASURE mode.

The pump also operates for a short period during this sequence.

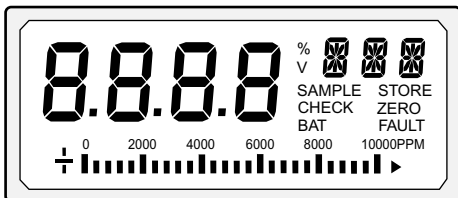

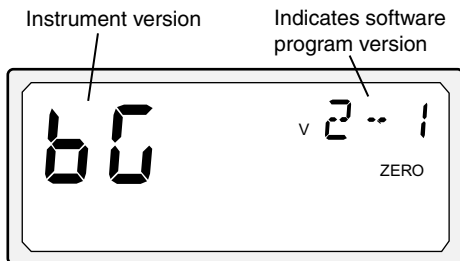

but with ZERO flag activated

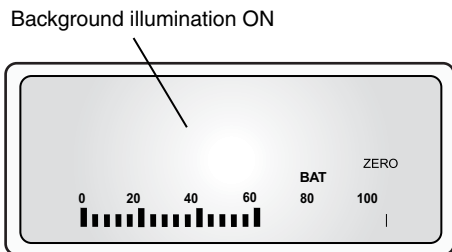

Instrument will enter the ZERO mode, indicated by ZERO in the status display and zero the instrument automatically.

Only Zero errors of less than 4% can be zeroed by this function.

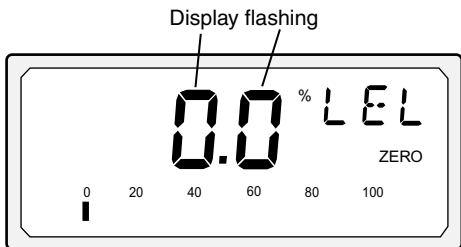

If this operation does not reset the zero and remove the ZERO FAULT or CHECK ZERO flags, the instrument should be returned to the service centre for checking.

The instrument switches OFF automatically from the ZERO mode.

The instrument can only be zeroed by switching OFF from the MEASURE mode.

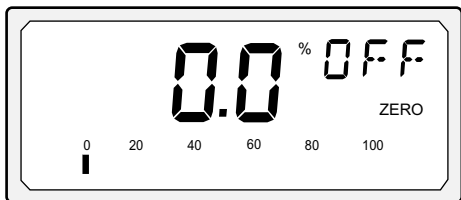

OPERATOR MESSAGES

A number of messages can appear in the display window, indicating instrument status and operator action.

READ AND UNDERSTAND HANDBOOK BEFORE USE

SAMPLE

Indicates that the pump is running and the instrument is sampling.

OFF

Indicates that the instrument is about to switch OFF
Can be reset by pressing MEASURE button once.

SAMPLE FAULT

Indicates that the instrument sample flow is incorrect due to sample path blockage or pump failure.

CHECK ZERO

Indication that there may have been a zero shift due to the presence of gas. Switch off the instrument and switch on again in fresh air.

ZERO FAULT

Indicates that zero is outside calibration limits.

Switch instrument OFF and initiate ZERO sequence with instrument in fresh air to reset zero.

BAT 'Flashing'

Indicates that the batteries will soon require replacement as indicated by BAT FAULT flag.

BAT FAULT

Indicates that the batteries require replacement.

ZERO

Indicates that the instrument is in the ZERO mode.

PROBE

The instrument is provided with a probe containing both a cotton and a hydrophobic filter.

The probe ends can be changed to provide a short probe with an open end, or a long probe with a closed end.

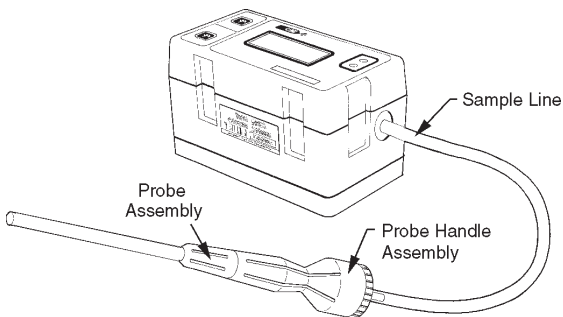

The filters in the probe should be changed by the operator as required.

The cotton filter should be changed on a regular basis, say once per week depending on use, when dirty, contaminated by water, etc.

The hydrophobic filter should only be replaced when contaminated with dirt or water and cannot be cleared.

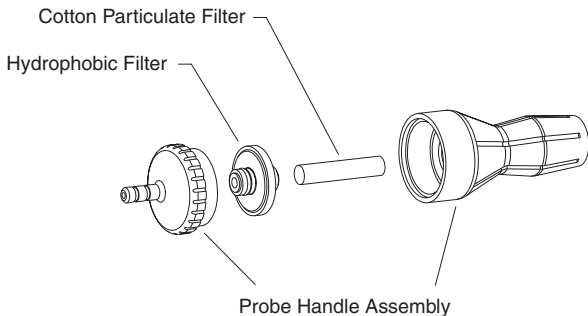

The sample line is permanently attached to the probe by means of a clip.

The instrument should not be used without the probe and its filters in place.

The probe filters help maintain a clean flow path and, properly used, prevent the ingress of water into the instrument itself.

Should water enter the probe filters, the instrument pump should turn off and the instrument should display a flashing SAMPLE FAULT together with a flashing display to indicate the pump is not operating.

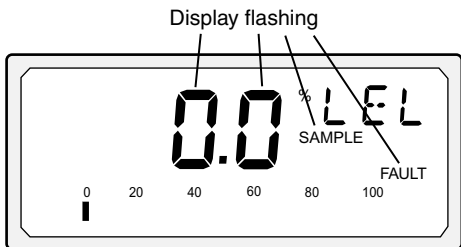

- 1) Check to ascertain whether water has entered the probe.
- 2) Disconnect probe sample line from instrument.
- 3) Remove probe handle from probe end.

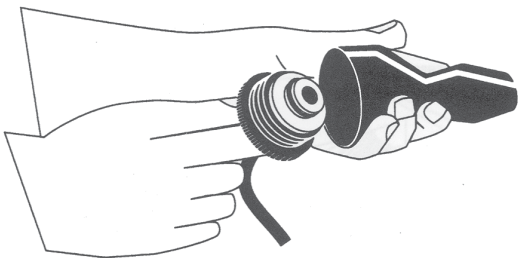

- 4) Remove cotton filter and discard.

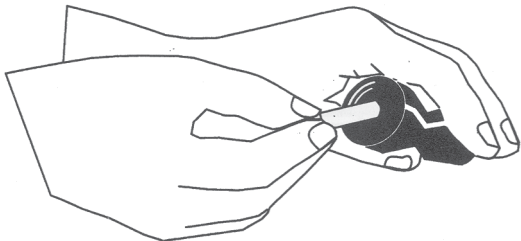

- 5) Remove hydrophobic filter, noting which way filter is fitted. (label on filter against label on probe end).
- 6) With the inlet side of filter (i.e. non label side of filter facing downwards) tap out any water and ensure the filter is not contaminated with dirt.
- 7) Check sample line is clear of water before replacing hydrophobic filter.

If necessary, use aspirator bulb to blow into the outlet (i.e. label side) to remove any residual water.

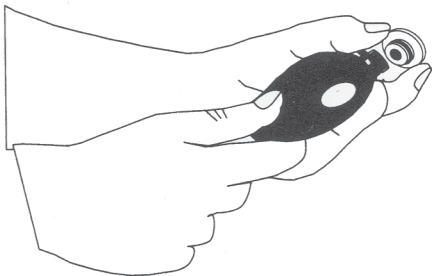

- 8) Replace hydrophobic filter, ensuring that you replace it in the same way as it was before (i.e. label on filter against label on probe handle).

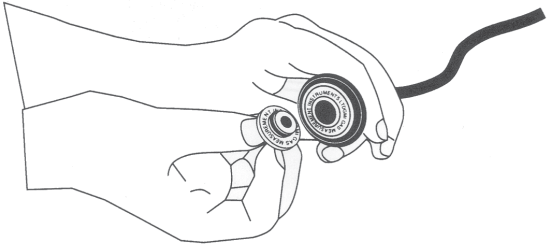

- 9) Fit new cotton filter into probe handle.

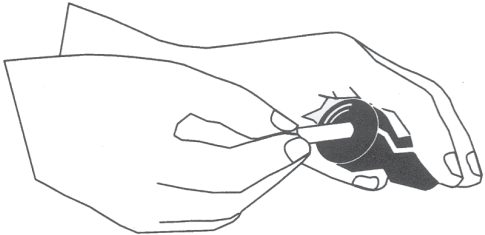

- 10) Reassemble probe handle and reconnect to instrument.

Make sure that instrument will operate without activating SAMPLE FAULT flag when pump is running, to ensure that filter is clear.

Sample flag operates with MEASURE button
and no SAMPLE FAULT flag flashing

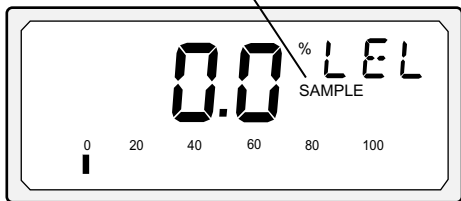

If SAMPLE FAULT continues to activate, fit a new hydrophobic filter.

Do not discard old hydrophobic filter since it will probably operate correctly when water has dried out in hydrophobic membrane.

SAMPLE LINE

The probe is supplied complete with 1.5 metres of sample line attached.

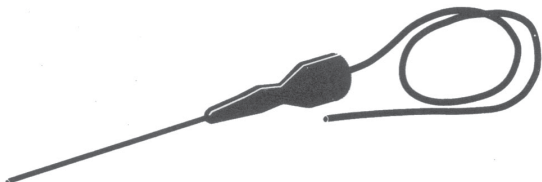

The sample line is connected to the right hand inlet nozzle of the instrument.

The sample line fits easily over the male spigot of the inlet nozzle.

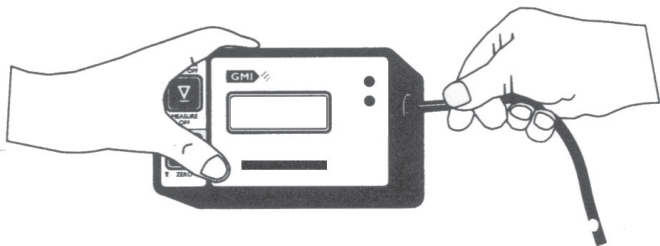

Make sure that the sample line is in good condition, is not split or perished, and forms a good seal with the inlet nozzle.

LEL / GAS MEASUREMENTS

Relationship of LEL and % Methane (Natural Gas) in Air

% LEL (Lower Explosive Limit)

i.e. the lowest concentration of METHANE (NATURAL GAS) in air that can cause an explosion. This figure varies for every explosive gas and is approximately 5% Gas for METHANE (NATURAL GAS)

e.g.	100% LEL	=	5% Gas
	10% LEL	=	0.5% Gas
	1% LEL	=	0.05% Gas

% UEL (Upper Explosive Limit)

i.e. the highest concentration of METHANE (NATURAL GAS) in air that can cause an explosion. Again, this figure is gas specific and is approximately 15% Gas for METHANE (NATURAL GAS).

Note: UEL is not in common usage as a unit because, while a concentration of 20% gas is greater than the explosive limit, it still represents a hazard since dilution with air can produce an explosive mixture.

% GAS

In this case, the percentage of METHANE (NATURAL GAS) in Air, i.e. 10% Gas = a mixture of 10% METHANE (NATURAL GAS) and 90% Air.

Note: Emphasis must be made that any reference to %

LEL and % GAS in this handbook relates to a METHANE (NATURAL GAS) in Air mixture only, as the presence of other gases can have a significant effect on the explosivity of the mixture.

The relationship between LEL and % METHANE (NATURAL GAS) in Air is shown in the following table:

% L.E.L.	% Methane In Air (Natural Gas)
0	0
1%	0.05%
2.5%	0.125%
4.0%	0.2%
6.0%	0.3%
8.0%	0.4%
10.0%	0.5%
12.0%	0.6%
14.0%	0.7%
16.0%	0.8%
18.0%	0.9%
20.0%	1.0%
30.0%	1.5%
40.0%	2.0%
50.0%	2.5%
60.0%	3.0%
70.0%	3.5%
80.0%	4.0%
90.0%	4.5%
100.0%	5.0%

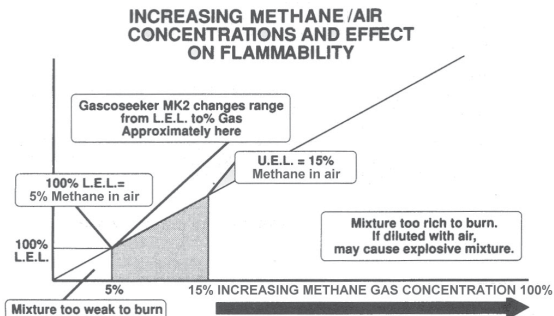

BATTERY LIFE

- 1) To obtain the 15 hours operating life specified you should use only LR20 alkaline cells.
- 2) Only 4 new cells should be fitted. When the cells are low or exhausted it is necessary to fit 4 new cells to reset the battery indicator bar graph to 100%.
- 3) Partially used cells will not achieve the battery reset function and will result in less usage from partially used cells.
Do not mix new and old cells.
- 4) 15 hours operational life will only be attained at ambient temperature 15°C - 20°C since battery capacity is affected by temperature.
- 5) The battery bar graph gives an indication of battery life, but may not be totally linear.

A typical battery bar graph shape is shown in the following diagram:

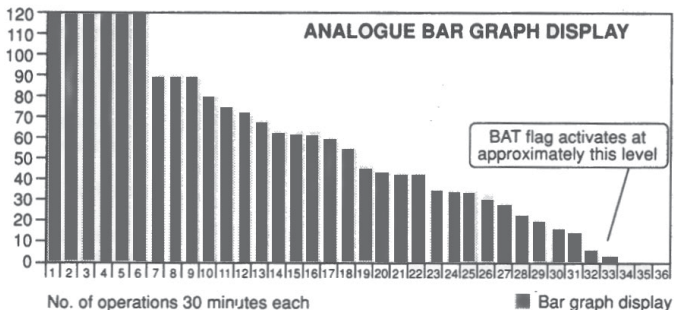
INDICATION ON
ANALOGUE BAR GRAPH

- 7) When BAT alarm flag is initiated there should be typically 1 - 2 hours life left for operation at normal temperature when alkaline cells are used.
- 8) BAT warning flag is a warning; the instrument may continue to be used until it switches off automatically.
- 9) Check battery condition before use. If signs of leakage or damage do not use.

Battery Safety Code

Used correctly, primary cells/batteries are a safe and dependable source of portable power.

Problems can occur if they are abused, resulting in leakage or other incidents which could cause equipment failure or personal injury.

Here are some simple rules to help eliminate such problems.

ALWAYS

Take care to fit your batteries correctly, observing the + and - markings on the battery and the instrument.

ALWAYS

Replace the whole set of batteries at one time, taking care not to get old and new batteries or batteries of different types mixed, since this can result in leakage, overheating or other failures.

ALWAYS

Keep unused batteries in their packing and away from metal objects which may cause a short circuit resulting in leakage or generation of high temperature.

ALWAYS

Remove spent batteries from the instrument and all batteries from instruments unused for long periods. Otherwise the batteries may leak and cause damage.

ALWAYS

Make sure the cells are undamaged, in good condition, in contact with the springs and the battery compartment cover is secure, when replacing batteries and before instrument use.

Spare batteries can be kept in the carrying case for field replacement.

NEVER

Use or handle batteries which are physically damaged, leaking or heating up when not in circuit.

NEVER

Dispose of batteries in fire as this can cause them to explode.

NEVER

Attempt to recharge a dry cell. They may leak or explode.

Battery Replacement

If the BAT flag appears:

- or you are unable to SWITCH THE PUMP ON
- or you are unable to SWITCH THE INSTRUMENT ON
- or you are unable to SWITCH THE INSTRUMENT OFF

.. THE BATTERIES MAY REQUIRE REPLACEMENT

ATEX approved instruments -

You can only use the following approved

Alkaline Batteries:

Duracell Industrial ID1300 Size: D (LR20)

Duracell Procell MN1300 Size: D (LR20)

Ever Ready Energiser Size: D (LR20)

The Gascoseeker 2-500 contains four (4) batteries. All should be replaced at any one time with fresh batteries.

To Replace the batteries, proceed as follows:

- 1) **Operate in a safe area.**
- 2) **Switch Instrument OFF** before starting to replace.
- 3) Loosen instrument base plate screws (4mm. hexagonal x 2) using special tool provided.

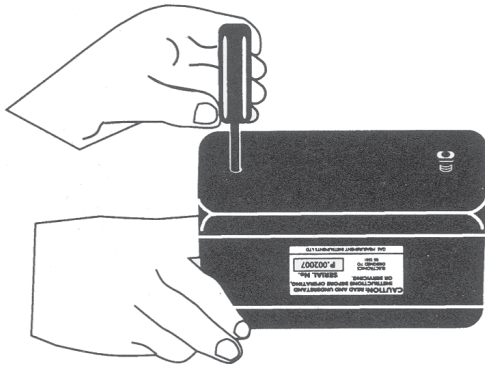

4) Remove battery cover

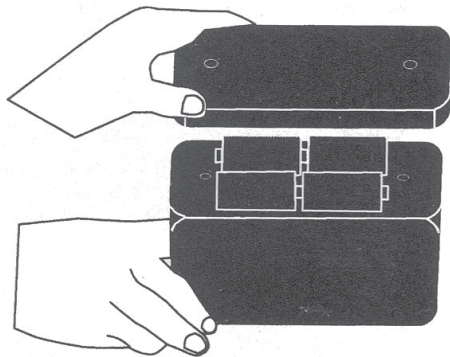

- 5) Remove old batteries

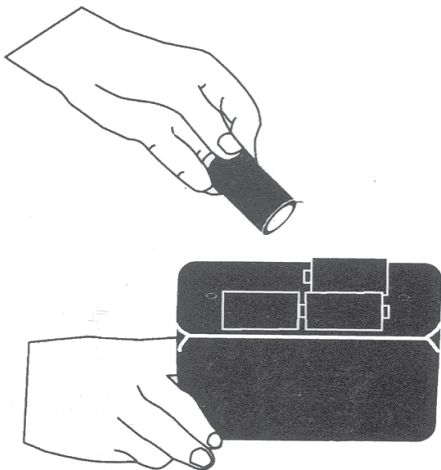

- 6) Check battery compartment for damage to spring contacts or corrosion on springs.

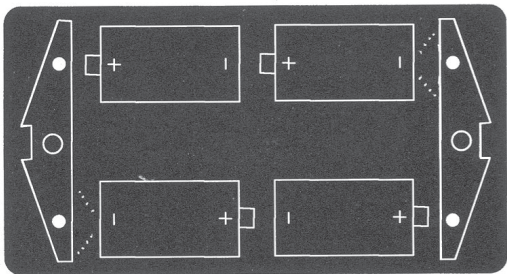

- 7) Replace all four (4) batteries with new units.

Observe correct polarity with indicator marked in battery compartment base.

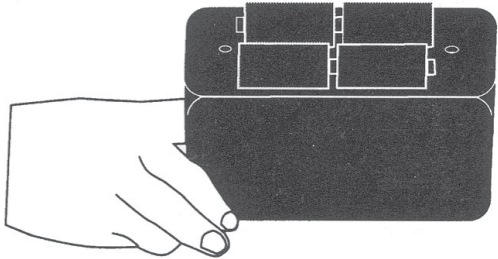

- 8) Replace base plate and fasten base screws.

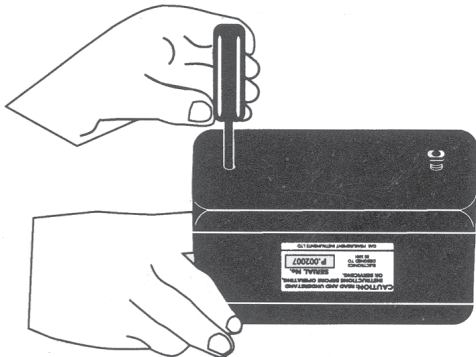

- 9) Check that instrument switches ON, battery indicator and analogue display is satisfactory at switch ON.

ASPIRATOR BULB

An aspirator bulb is provided should the pump fail, to enable a sample to be taken.

The aspirator bulb is fitted with an adaptor to enable it to connect to the instrument outlet. It will not connect to the inlet.

Ensure that the bulb has an adaptor fitted.

The bulb should be checked periodically to ensure that it is functioning correctly.

Place finger over inlet hole in bulb adaptor and close inlet i.e. Hole in stainless steel adaptor and depress bulb.

Bulb should not re-inflate whilst hole in adaptor is covered.

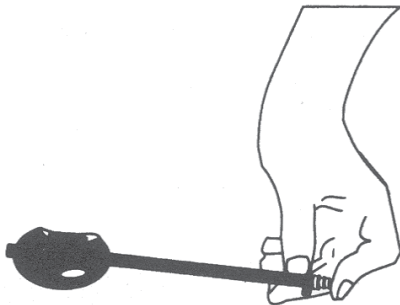

Release finger from inlet hole and bulb should re-inflate in less than 5 seconds.

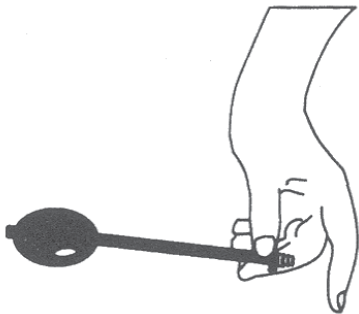

The bulb can be used to aspirate the instrument in the event of pump failure. Normally this would be indicated by either

- 1) Flashing digital display.
- 2) Absence of SAMPLE flag on display.
- 3) Flashing SAMPLE FAULT on display.

If these cannot be cleared by

- New batteries
 - Switching instrument OFF and ON again
 - Operation of MEASURE button to operate pump
 - Checking for water ingress in probe, clearing and replacing filters
 - Ensuring that sample line is not blocked
- . . then the aspirator can be used in an emergency to draw sample through instrument.

Connect aspirator bulb to outlet of instrument.

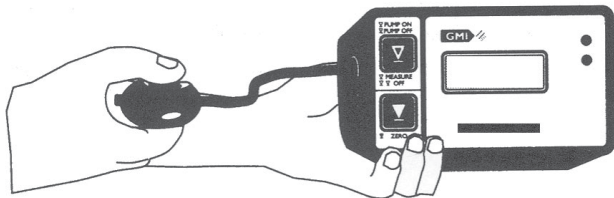

The connection may not be leak free, however, this should not affect instrument performance.

Aspirate sample through instrument as desired.

Remember that display may be flashing since this is an indication of pump not running.

Only use this as an emergency and return instrument to instrument workshop for repair immediately.

Carrying Straps

The carrying straps on the instrument are removable and adjustable.

They include a shoulder pad and 'D' shaped loops for attachment of a waistband harness, (where desired).

The waistband harness is not supplied with the instrument as standard, but is available as an accessory.

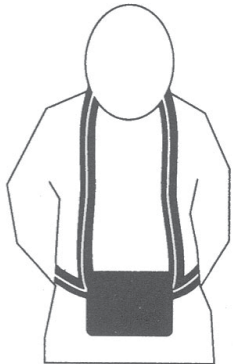

To affix to instrument, apply circular hole in key slot on strap to clip to stainless steel boss on instrument body.

Locate clip flush against instrument body.

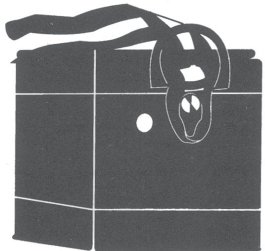

Pull strap upwards until strap clip locates firmly on stainless steel boss with sharp click.

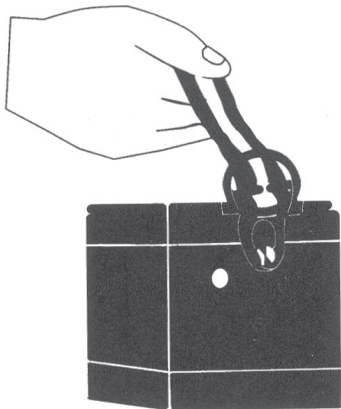

Strap can be adjusted to length by means of buckle.

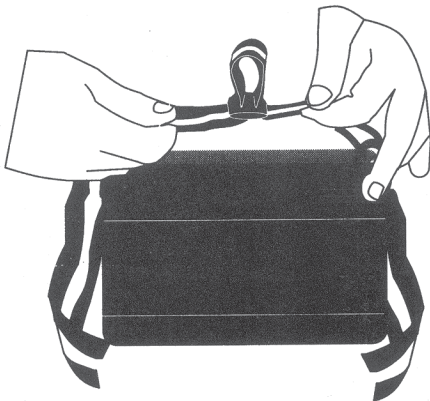

Excess strap length can be clipped into open slot on top of strap clips.

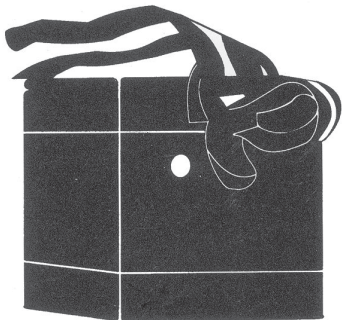

WAISTBAND HARNESS

The waistband harness is supplied as an accessory.

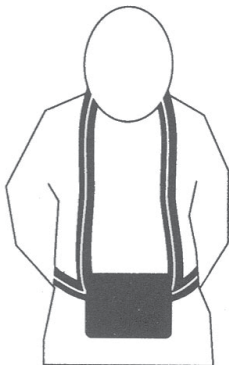

The waistband harness is attached to the instrument using the 'D' clips on the shoulder harness.

INSTRUMENT COTTON FILTER

A cotton filter is not normally fitted within the instrument since this normally is incorporated into the probe handle.

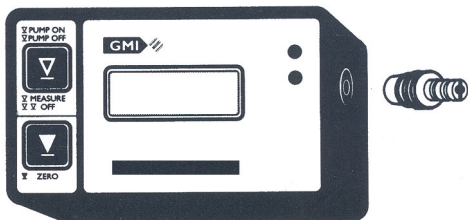

However where the instrument is to be used without the probe handle provision is made within the instrument to incorporate a separate cotton filter.

This should not be used with a cotton filter in the probe handle.

Filter can be fitted by removing the stainless steel inlet nozzle from the instrument using a one pence coin or similar in nozzle slot and unscrewing in an anti clockwise direction.

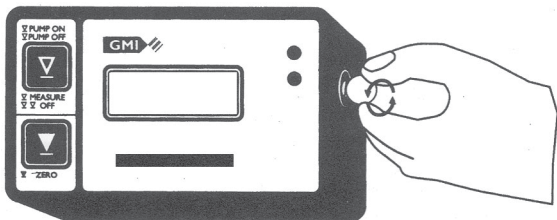

When nozzle is removed filter can be placed in nozzle not in instrument.

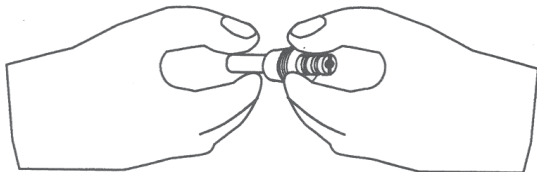

Nozzle and filter should then be placed in instrument, checking that 'O' ring seal on nozzle is not damaged before replacing.

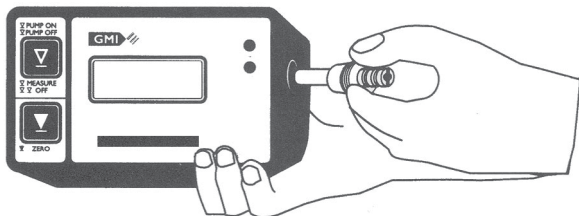

The cotton filter in instrument should be removed after use.

This filter should not be used with the normal probe since it already incorporates a cotton filter and two filters in the line can affect instrument performance.

The instrument cotton filter should only be used under exceptional circumstances when it is not possible to use the normal probe.

e.g. long sample line necessary and access for probe handle too narrow.

FAULT FINDING

If the instrument does not appear to be functioning correctly it should be returned to the supervisor or workshop for checking and if necessary repair. There are a number of faults which can be checked and rectified by the user before sending to the instrument workshop.

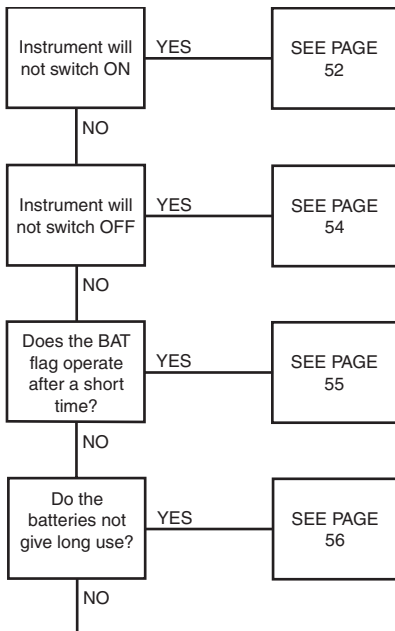

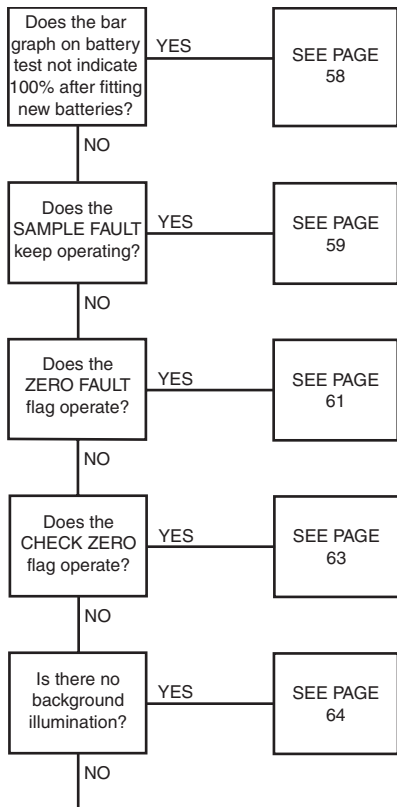

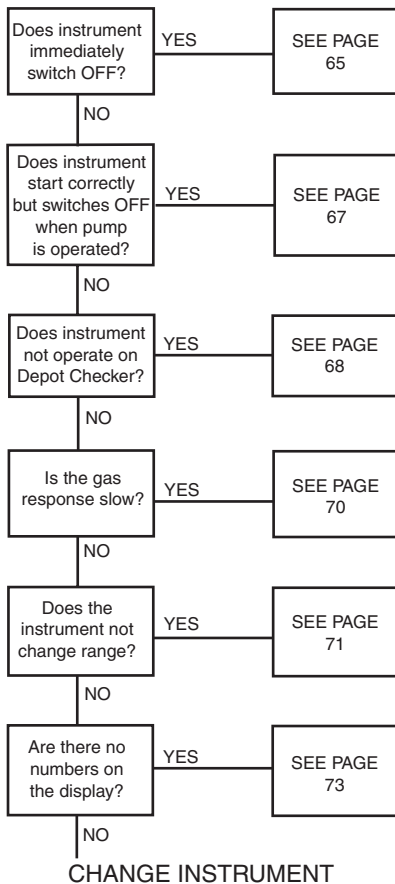

Fault Finding

IF IN DOUBT HAVE THE SUPERVISOR OR TECHNICAL STAFF CHECK THE INSTRUMENT FOR YOU

INSTRUMENT WILL NOT SWITCH ON

ARE BATTERIES FITTED?

Instrument would normally be supplied without batteries fitted to ensure that only fresh batteries are used at the time of use.

In addition the storage of instruments without batteries prevents any problems associated with battery leakage in the instrument.

ACTION: *FIT BATTERIES*

ARE BATTERIES OPERATIONAL?

Check and make sure that only fresh new alkaline batteries are used.

Batteries which have been used in other equipment should not be used.

ACTION: *FIT NEW BATTERIES*
 - IF IN DOUBT FIT NEW BATTERIES

ARE BATTERIES CORRECTLY FITTED?

The batteries have to be fitted in the battery compartment in the correct way and in the correct alignment

Check that the + and - symbols on the batteries line up with those on the battery compartment and its labels.

Make sure that the batteries are in contact with the terminals and each other A good tip is to rotate the batteries

once they are all in the battery compartment, to check that they are free and in contact.

ACTION: *CHECK ORIENTATION OF BATTERIES*

ARE CONTACTS ON BATTERIES AND TERMINALS DIRTY?

If the batteries or the Instrument terminals are dirty they may not make a good enough contact to enable correct operation to take place.

They can be cleaned using a clean dry cloth; do not use solvents, contact cleaners, grease etc. If in doubt return instrument to workshop for checking. If battery has leaked causing contamination of contacts, instrument should be returned to workshop without cleaning.

ACTION: *CHECK BATTERIES AND CONTACTS FOR CLEANLINESS*

WILL INSTRUMENT SWITCH ON USING:

1) MEASURE BUTTON?

2) ZERO BUTTON?

Instrument should switch on in either sequence although it will do different things. If it does not, then the instrument should be returned to workshop for checking.

ACTION: *IF INSTRUMENT DOES NOT SWITCH ON USING BOTH PUSH BUTTONS. RETURN TO WORKSHOP*

INSTRUMENT WILL NOT SWITCH OFF

DOES OFF APPEAR ON DIGITAL DISPLAY?

The OFF legend should appear in the LCD display to indicate the OFF sequence. This happens when instrument has been running for approximately 30 minutes or the MEASURE button has been pressed twice in rapid succession.

Check if the instrument is being calibrated, Depot checked or is connected to an alarm unit. In the communications mode, the 30 minute time is inhibited and the instrument will continue to run until switched off manually or until the batteries are exhausted.

ACTION: CHECK OFF LEGEND APPEARS

DOES MEASURE PUSH-BUTTON INITIATE OFF SEQUENCE?

Two rapid operations of measure button should cause instrument to enter OFF sequence and the OFF flag to appear in display.

Operation of push-button is usually accompanied by a bleep from internal buzzer unless instrument is in communications mode.

*ACTION: CHECK OPERATION OF MEASURE
PUSH-BUTTON*

BAT FLAG OPERATES AFTER SHORT TIME

ARE BATTERIES NEAR END OF LIFE?

Normal life from a set of good quality alkaline batteries is in excess of 15 hours operation. If pre-used or poor quality batteries are used the battery life may be substantially reduced.

ACTION: *REPLACE BATTERIES WITH GOOD QUALITY ALKALINE CELLS*

IS TEMPERATURE BELOW FREEZING?

The operating performance of the batteries is given at normal room temperature; although the batteries will operate below freezing their operating time can be substantially reduced.

Keep spare batteries at room temperature for a few hours if *you* are using the instrument below freezing.

ACTION: *KEEP A SET OF SPARE BATTERIES IN THE HEATED VAN CAB RATHER THAN IN THE UNHEATED SECTION IN COLD WEATHER CONDITIONS.*

ARE FILTERS BLOCKED OR SAMPLE FLAG ACTIVATED?

If the batteries are poor quality or are nearly at the end of their life, then a restriction or blockage on the sample line causing increased pump load may cause battery voltage to decrease, giving BAT flag after short period.

ACTION: *REPLACE BATTERIES WITH FOUR NEW LR20 ALKALINE CELLS*

BATTERIES DO NOT GIVE LONG USE

HAVE NEW BATTERIES BEEN USED?

Alkaline batteries will give up to 15 hours use in normal conditions, pre-used or poor quality batteries should not be used in the instrument

ACTION: *REPLACE BATTERIES WITH FOUR NEW LR20 ALKALINE CELLS.*

ARE LR20 ALKALINE BATTERIES FITTED?

Only LR20 alkaline cells will give the specified instrument performance.

ACTION: *USE ONLY LR 20 ALKALINE CELLS*

ARE ALL FOUR BATTERIES OF THE SAME MAKE AND TYPE?

All four batteries should be replaced at one time with new cells of the same make and type

DO NOT MIX BATTERY TYPES

ACTION: *REPLACE ALL FOUR CELLS WITH NEW LR20 ALKALINE CELLS*

HAS INSTRUMENT BEEN USED AT LOW TEMPERATURE?

The instrument performance of 15 hours is given at ambient temperature between 15 Deg.C and 20 Deg.C; at lower temperatures, particularly below freezing, battery capacity can be dramatically reduced. Where the instrument is being used at low temperature, replacement batteries should be stored in warmer conditions where possible

ACTION: *CHECK INSTRUMENT PERFORMANCE AT AMBIENT TEMPERATURES*

ARE BATTERIES REPLACED WHEN BAT OR BAT FAULT INDICATOR IS ACTIVATED?

Batteries would normally be replaced when the BAT FAULT flag is activated to achieve maximum battery life, however a work programme should not be commenced with the BAT flag activated and no spare batteries

The operational time between the BAT and BAT FAULT flags depends on the particular batteries fitted, specific instrument characteristics, ambient temperature and other factors.

ACTION: CHECK WHEN BATTERIES ARE CHANGED.

IS INSTRUMENT SWITCHED OFF MANUALLY OR LEFT TO SWITCH OFF AUTOMATICALLY AFTER USE?

The instrument switches off automatically after 30 minutes running, to conserve battery life, and to ensure that it is unlikely you will be left with a non- functioning unit because you forgot to switch it off.

If you do not switch the instrument off after use then each operation of the instrument will be 30 minutes: if you only use it for 5 minutes then the battery life may appear to be excessive relative to use. The instrument has an internal hours run counter that records the actual time operational

ACTION: ALWAYS SWITCH INSTRUMENT OFF MANUALLY AFTER USE

BAR GRAPH ON BATTERY TEST DOES NOT INDICATE 100% AFTER FITTING NEW BATTERIES

ARE 4 NEW ALKALINE BATTERIES FITTED?

The bar graph indicates the battery condition at the last switch off to give a representative indication of potential battery life

It can only be reset by replacing all four batteries with four new good alkaline cells at the same time. The use of mixed or partially used batteries may not reset the battery indicator. The use of other types of battery, whether good or not, may also not reset the indicator, may cause the instrument to malfunction and may in themselves be dangerous in gaseous atmospheres.

ACTION: *REPLACE ALL CELLS WITH FOUR NEW LR20 ALKALINE BATTERIES*

HAVE BATTERIES BEEN KEPT AT LOW TEMPERATURE FOR A PERIOD OF TIME?

Battery capacity is a function of temperature and batteries stored at low temperature are not able to release their total power potential.

If the batteries have been stored in a vehicle overnight at below zero they may appear to have less capacity. Where possible, batteries should be at ambient temperature before use, even if instrument is being used in low temperature conditions. Store replacement batteries in vehicle cab rather than in unheated compartment.

ACTION: *KEEP REPLACEMENT BATTERIES AT AMBIENT TEMPERATURE 1-2 HOURS BEFORE USE*

ARE ALL BATTERIES OF SAME TYPE?

Only LR20 alkaline batteries should be used and they should all be from the same manufacturer.

DO NOT MIX BATTERY TYPES OR MANUFACTURERS

ACTION: *ENSURE THAT LR20 ALKALINE
BATTERIES FROM ONE
MANUFACTURER ARE FITTED*

ARE RECHARGEABLE BATTERIES BEING FITTED?

Under no circumstances should rechargeable cells be fitted to the instrument.

ACTION: *ENSURE THAT LR20 ALKALINE
BATTERIES ARE FITTED*

SAMPLE FAULT KEEPS OPERATINGIS THERE WATER IN PROBE OR SAMPLE LINE?

When the filters in the probe are blocked with water the SAMPLE FAULT flag should be activated in the instrument to indicate this to the operator. The operation of the pump monitor is inhibited at low temperatures.

ACTION: *CHECK SAMPLE LINE AND FILTERS
FOR CONTAMINATION.*

DO PROBE FILTERS REQUIRE CHANGING?

If the filters have been used for long periods in dirty atmospheres they may be contaminated and require changing.

ACTION: *CHECK CONDITION OF FILTERS.*

HAS INSTRUMENT BEEN SWITCHED OFF AND ON AGAIN WITHOUT SAMPLE LINE ATTACHED?

It may be necessary to switch the instrument OFF and ON again to enable the flow sensor to initiate the test conditions at start up which include the back pressure of the sample line and probe.

ACTION: SWITCH OFF. CHECK SAMPLE LINE AND FILTERS AND SWITCH INSTRUMENT ON AGAIN.

HAS INSTRUMENT BEEN SWITCHED OFF AND ON AGAIN WITH CLEAN SAMPLE LINE, PROBE AND FILTERS ATTACHED?

It may be necessary to switch the instrument OFF and ON again, to enable the flow sensor to initiate the test conditions at start up which include the back pressure of the sample line and probe, after new filters have been fitted.

ACTION: SWITCH OFF, CHECK SAMPLE LINE AND FILTERS AND SWITCH INSTRUMENT ON AGAIN.

HAVE NEW BATTERIES BEEN FITTED?

Battery capacity may be limited due to a number of factors such as low temperature, poor cells, etc. When the pump is operated under bad conditions, the increased current with low capacity batteries and low temperature may cause an increase in motor current which could initiate a SAMPLE FAULT

ACTION: CHANGE BATTERIES IF IN DOUBT.

IS TEMPERATURE BELOW FREEZING?

Low temperature reduces battery capacity and may increase pump current, thus causing SAMPLE FAULT conditions. In addition any moisture or water on the filters from previous tests which have not been completely removed, may freeze and cause an increased load on the pump causing a SAMPLE FAULT

ACTION: *CHECK OPERATION AT AMBIENT TEMPERATURE.
REPLACE BATTERIES WITH ONES KEPT AT AMBIENT.
CHECK FILTERS AND REPLACE AS NECESSARY.*

ZERO FAULT FLAG OPERATESHAS INSTRUMENT BEEN ZEROED IN FRESH AIR?

If instrument has not been zeroed in fresh air in the last test, or has gas in the flow path from being switched off with gas in the sample line, then a false zero condition may be detected by instrument.

ACTION: *ALLOW INSTRUMENT TO FLUSH THROUGH WITH FRESH AIR. SWITCH OFF AND INITIATE ZERO SEQUENCE IN FRESH AIR.*

HAS INSTRUMENT BEEN USED TO MEASURE
PETROL, BUTANE OR SOME OTHER SUBSTANCE
OTHER THAN METHANE?

If instrument has been used for a heavy hydrocarbon or a volatile substance such as Petrol, this may be impregnated into the filters or some residue may be in sample line, which will register as a false zero in the zero check sequence.

*ACTION: CHECK FILTERS FOR CONTAMINATION.
CHANGE. IF NECESSARY.
REMOVE SAMPLE LINE AND PROBE.
SWITCH INSTRUMENT OFF.
INITIATE A ZERO SEQUENCE IN FRESH
AIR.*

HAS INSTRUMENT BEEN SWITCHED OFF IN GASEOUS
ATMOSPHERE?

If the instrument was switched off with gas in the sample path then some may remain and this would alter the zero setting, which would be detected by the instrument and indicated as a ZERO FAULT.

*ACTION: FLUSH INSTRUMENT WITH FRESH AIR
SWITCH OFF
INITIATE A ZERO SEQUENCE IN FRESH
AIR.*

CHECK ZERO FLAG OPERATES

HAS INSTRUMENT BEEN SWITCHED ON IN GASEOUS ATMOSPHERE?

If the instrument has been switched on in an atmosphere which contained some gas, then a CHECK ZERO warning may be flagged to the operator as a warning. This will depend upon the exact concentration.

ACTION: *RE-ZERO INSTRUMENT IN GAS-FREE FRESH AIR*

WHEN WAS INSTRUMENT LAST ZEROED?

The instrument should be zeroed at regular intervals. e.g. once per day or before use, if it has not been used for several days.

ACTION: *INITIATE ZERO SEQUENCE IN FRESH AIR*

HAS INSTRUMENT BEEN USED TO MEASURE GASES OR VAPOURS OTHER THAN METHANE?

If the instrument has been used to measure heavy hydrocarbons, petrol or similar then some residue may be in filters or probe.

ACTION: *REMOVE SAMPLE LINE AND PROBE.
INITIATE ZERO SEQUENCE IN FRESH AIR.
CHECK PROBE AND FILTERS FOR CONTAMINATION.
RE-APPLY SAMPLE LINE AND PROBE AND CHECK INSTRUMENT ZERO.*

BACKGROUND ILLUMINATION DOES NOT OPERATE

IS INFRA RED LINK CLEAN ON INSTRUMENT TOP PLATE?

The infrared sensor also detects the ambient light condition and requires the apertures to be clear.

ACTION: *USE A DRY CLOTH TO REMOVE ANY FOREIGN MATERIAL OR DEBRIS FROM THE INFRARED APERTURE ON THE TOP PLATE.*

IS BACKGROUND LIGHT LEVEL SUFFICIENTLY LOW?

The background illumination will only be initiated when the ambient lighting is sufficiently low that the scale cannot be read.

ACTION: *ENSURE THAT AMBIENT LIGHT IS LOW ENOUGH IN AREA OF INFRARED SENSOR.*

IS INSTRUMENT BEING USED ON A DEPOT CHECKER, CONNECTED TO AN ALARM UNIT OR BEING CALIBRATED?

When instrument is on a DEPOT CHECKER, or is connected to any other equipment via the infra red link, then background illumination is inhibited.

ACTION: *REMOVE INSTRUMENT FROM CHECKER OR ANY OTHER CONNECTION.
SWITCH INSTRUMENT OFF.
SWITCH ON AGAIN AND CHECK ILLUMINATION.*

INSTRUMENT SWITCHES ON AND IMMEDIATELY SWITCHES OFF

IS BAT OR BAT FAULT FLAG ACTIVATED?

If batteries have low capacity or are of poor qual~ they may provide sufficient power for a short time, thus enabling the instrument to switch on, but rapidly dropping sufficiently to initiate automatic shutdown via the BAT FAULT flag.

ACTION: *REPLACE BATTERIES WITH NEW LR20 ALKALINE BATTERIES.*

ARE BATTERIES OF THE CORRECT TYPE?

Only good quality alkaline batteries of the LR20 type should be used; do not mix types of manufacturer.

ACTION: *REPLACE BATTERIES WITH GOOD QUALITY NEW LR20 ALKALINE CELLS.*

IS TEMPERATURE LOW?

At low temperature the battery voltage may not be sufficient to operate instrument. The minimum operating temperature for LR20 alkaline cells is -20 Deg.C.

ACTION: *REPLACE BATTERIES WITH NEW CELLS THAT HAVE BEEN KEPT AT AMBIENT TEMPERATURE.*

ARE SAMPLE LINE AND INSTRUMENT FILTERS CLEAR?

If the sample line and filters are blocked and the batteries low, then the battery voltage may be pulled low by increased pump current. This may initiate a BAT FAULT and automatic shutdown.

*ACTION: CHECK FILTERS AND SAMPLE LINE ARE CLEAR.
REPLACE BATTERIES IF NECESSARY.*

DOES INSTRUMENT COMPLETE ZERO SEQUENCE?

If the instrument has a ZERO FAULT above a certain level, or the zero data in the instrument is corrupt, then the start up sequence tests cannot be completed satisfactorily.

*ACTION: REPLACE BATTERIES.
ZERO INSTRUMENT AND RE-INITIATE MEASURE SEQUENCE.
IF NOT SUCCESSFUL INSTRUMENT MUST BE RETURNED TO WORKSHOP.*

INSTRUMENT STARTS CORRECTLY BUT SWITCHES OFF WHEN PUMP OPERATED

IS TEMPERATURE LOW?

If the temperature is low the battery capacity may be reduced and the pump current increased, thus causing battery voltage to be reduced below the automatic shutdown level when the pump is switched ON.

ACTION: *REPLACE BATTERIES WITH NEW CELLS THAT HAVE BEEN STORED AT AMBIENT TEMPERATURE THEN TRY SEQUENCE AGAIN.*

ARE SAMPLE LINE AND FILTERS CLEAR?

Low batteries used in low temperatures with a blocked sample line or filters, may reduce battery voltage below the automatic switch off point, thus causing the instrument to switch OFF.

ACTION: *CHECK SAMPLE LINE AND FILTERS FOR BLOCKAGE.*

HAVE NEW BATTERIES BEEN FITTED?

If the batteries are below capacity or they are not of good quality, then they may reduce in voltage when the pump is operated, thus switching the instrument OFF.

ACTION: *REPLACE BATTERIES WITH GOOD QUALITY LR20 ALKALINE CELLS.*

ARE LR20 ALKALINE BATTERIES USED?

Only LR20 Alkaline cells will give the specified performance

ACTION: *REPLACE ALL BATTERIES WITH NEW ALKALINE LR20 CELLS.*

INSTRUMENT DOES NOT OPERATE ON DEPOT CHECKER

HAS INSTRUMENT BEEN ISSUED TO DEPOT?

Instrument and Depot Checker require to be set up by technical staff to ensure that they are operating correctly.

ACTION: *CHECK WITH SUPERVISOR THAT THE INSTRUMENT HAS BEEN ISSUED FOR USE ON DEPOT CHECKER.*

DO OTHER INSTRUMENTS OPERATE ON DEPOT CHECKER?

There may be a fault on the DEPOT CHECKER. If other instruments operate correctly on checker then DEPOT CHECKER is probably correct.

ACTION: *TRY OTHER INSTRUMENT ON CHECKER. IF SATISFACTORY, WAIT 5 MINUTES AND TRY AGAIN.*

REPORT INCIDENT TO SUPERVISOR EVEN IF INSTRUMENT OPERATES SECOND TIME.

DOES THE CHECKER HAVE THE CORRECT GASES AND DO THE CYLINDERS CONTAIN SUFFICIENT PRESSURE?

The Depot Checker will only operate satisfactorily if it has the correct gases connected to it and the gas pressures are correctly set.

ACTION: *CHECK WITH A SUPERVISOR OR AUTHORISED TESTER TO ENSURE DEPOT CHECKER IS OPERATING CORRECTLY.*

IS THE INSTRUMENT TOP PLATE CLEAN AROUND THE INFRARED LINK?

The instrument data is transmitted to the DEPOT CHECKER via the infrared link on the top plate. If this is dirty or obscured then the instrument may not be able to communicate with the checker.

ACTION: *CLEAN AREA AROUND INFRARED LINK WITH DRY CLOTH ENSURING ANY DEBRIS IS REMOVED FROM OPTICAL RECESS ON LINK.*

DO NOT WIPE MATERIAL INTO RECESS, RATHER BLOW IT OUT.

HAVE YOU FOLLOWED THE DEPOT CHECKER INSTRUCTIONS?

Instrument will only operate on DEPOT CHECKER if instructions are followed, particularly with regard to instrument being OFF when put on checker and MEASURE button only operated when DEPOT CHECKER requests it.

ACTION: *SWITCH INSTRUMENT OFF.
READ INSTRUCTIONS FOR CHECKER.
RE-TEST INSTRUMENT FOLLOWING INSTRUCTIONS EXACTLY.*

GAS RESPONSE IS SLOW

IS THE INSTRUMENT DETECTING METHANE?

The instrument response is setup using METHANE. If you are detecting other substances such as BUTANE. PETROL VAPOUR etc, the response may appear slow.

ACTION: *CHECK YOU HAVE CORRECT
INSTRUMENT FOR THE GAS YOU ARE
USING.*

IF IN DOUBT ASK SUPERVISOR.

ARE THE BAT OR BAT FAULT FLAGS ACTIVATED?

If the batteries are low, the pump flow rate may be reduced and hence the response time reduced.

ACTION: *CHANGE BATTERIES FOR NEW LR20
ALKALINE CELLS.*

IS THE SAMPLE LINE OR PROBE TRAPPED OR BLOCKED?

If the sample line or filters are blocked, the gas sample rate may be reduced.

ACTION: *CHECK FILTERS AND SAMPLE LINE
FOR BLOCKAGE, RESTRICTION OR
CONTAMINATION.*

REPLACE AS NECESSARY.

IS THE TEMPERATURE LOW?

If the temperature is low, the pump flow may be reduced because of battery voltage and any moisture in the filters may start to freeze, thus reducing flow rate.

ACTION: *REPLACE FILTERS WITH NEW ONES IF NECESSARY.*

REPLACE BATTERIES WITH NEW LR20 CELLS WHICH HAVE BEEN KEPT AT AMBIENT TEMPERATURE.

INSTRUMENT DOES NOT CHANGE RANGE**DOES THE INSTRUMENT COMPLETE THE MEASURE AND ZERO START UP SEQUENCES CORRECTLY?**

If the instrument has been left in the communications mode or has developed a fault then this may require to be reset.

ACTION: *SWITCH INSTRUMENT OFF.
ZERO INSTRUMENT.*

SWITCH ON IN MEASURE MODE TO TRY AGAIN.

IF STILL WILL NOT CHANGE RANGE, INFORM SUPERVISOR AND RETURN INSTRUMENT TO WORKSHOP.

HAS THE INSTRUMENT BEEN CALIBRATED OR CHECKED?

If the instrument has been calibrated or checked it may have been left in a non-range changing mode Switching instrument OFF and restarting it resets this function.

*ACTION: SWITCH OFF.
INITIATE ZERO SEQUENCE IN FRESH AIR.
SWITCH ON USING MEASURE BUTTON.
CHECK FOR RANGE CHANGE AND
RETURN TO SUPERVISOR.*

IS THE INSTRUMENT BEING USED TO MEASURE METHANE?

Since the L.E.L. and % Volume relationships with Methane are programmed into the instrument and they are different for other gases, the instrument may not indicate correctly if used on the wrong gas.

*ACTION: CHECK INSTRUMENT IS CALIBRATED
FOR THE GAS YOU ARE USING IT ON.*

NO NUMBERS ON DIGITAL DISPLAY

DOES INSTRUMENT COMPLETE ZERO SEQUENCE CORRECTLY?

If the digital display is blank it indicates a zero shift that the instrument may not be able to correct, and may give inaccurate readings. Thus the display is blanked to prevent incorrect use. Normally a ZERO FAULT flag would also be initiated.

ACTION:

SWITCH OFF.

INITIATE ZERO SEQUENCE IN FRESH AIR.

SWITCH INSTRUMENT ON IN MEASURE MODE.

IF CLEAR AND NO FAULT FLAGS, INSTRUMENT IS CORRECT.

IF DISPLAY STILL BLANK OR FAULT FLAG PRESENT, INFORM SUPERVISOR AND RETURN INSTRUMENT TO WORKSHOP.

Index

Symbols

% GAS 30
% Gas Range 5
% LEL 2, 30
% LEL Range 5
% UEL 30
% Volume Gas 2

A

AREAS OF USE ii
ASPIRATOR BULB 40

B

BACKGROUND ILLUMINATION 64
BAR GRAPH ON BATTERY TEST DOES NOT INDICATE 100% A 58
BAT 'Flashing' 22
BAT FAULT 22
BAT FLAG OPERATES AFTER SHORT TIME 55

BATTERIES DO NOT GIVE LONG USE 56
BATTERY LIFE 32
Battery Replacement 36
Battery Safety Code 34
BEFORE USE 12
BULB, ASPIRATOR 40

C

CALIBRATION 11
Carrying Straps 43
CONSTRUCTION 4
COPYRIGHT i
COTTON FILTER 47

D

DIGITAL DISPLAY 73
DISPLAY, DIGITAL 73
DISPOSAL ADVICE i

F

FAULT, BAT 22
FAULT FINDING 49
Fault Finding 52
FAULT, SAMPLE 22
FAULT, ZERO 22
FILTER, COTTON 47

G

GAS RESPONSE IS
SLOW 70
GENERAL 1

H

HANDLING ii
HARNES, WAISTBAND
46

I

ILLUMINATION,
BACKGROUND 64
INSTRUMENT COTTON
FILTER 47
INSTRUMENT DOES
NOT CHANGE
RANGE 71
INSTRUMENT DOES
NOT OPERATE ON
DEPOT CHECKER
68

INSTRUMENT STARTS
CORRECTLY BUT
SWITCHES OFF WHEN
67

INSTRUMENT SWITCHES
ON AND IMMEDIATELY
SWITCHES OFF 65

INSTRUMENT WILL NOT
SWITCH OFF 54

INSTRUMENT WILL NOT
SWITCH ON 52

L

LCD 7
LEL / GAS MEASUREMENTS
30
LEL Range Display 6
LIABILITY i
LIQUID CRYSTAL DISPLAY
7

M

MEASURE MODE 13
measuring ranges 1
MESSAGES, OPERATOR 22
MODIFICATION NOTICES i

O

OFF 22
OPERATING PROCEDURE
10
Operation 3
OPERATOR MESSAGES 22

P

PROBE 23
 PROCEDURE, OPERATING 10

R

ranges, measuring 1
 RANGES OF OPERATION 5
 Ready For Use 15
 Relationship of LEL and % Methane in Air 30
 Replacement, Battery 36
 REVISION RECORD iii

S

SAFETY ii
 SAMPLE 22
 SAMPLE FAULT 22
 SAMPLE FAULT KEEPS OPERATING 59
 Sample Finish 16
 SAMPLE LINE 29
 Sample Start 15
 SENSOR LIFE 8
 SOFTWARE i
 SPECIFICATION 9
 STORAGE ii
 Straps, Carrying 43
 Switch Off 17
 Switch ON 13

T

TRANSIT ii

W

WAISTBAND HARNESS 46

Z

ZERO 22
 ZERO FAULT 22
 ZERO FAULT FLAG OPERATES 61
 ZERO FLAG 63
 ZERO MODE 19

Head Office:

Inchinnan Estate, Renfrew, PA4 9RG Scotland

Telephone +44 (0)141 812 3211 Fax +44 (0)141 812 7820

<http://www.gmiuk.com>

Service Centre:

Crownhill, 25 Cochran Close,

Milton Keynes, MK8 OAJ

Telephone +44 (0)1908 568867 Fax +44 (0)1908 261056

